



Digital LCD Combi TV OWNER'S MANUAL

Please read this manual carefully before operating your set.
Retain it for future reference.
Record model number and serial number of the set.
See the label attached on the back cover and quote this information to your dealer when you require service.

Model number :
Serial number :



P/NO : 3828TUL261C(1EA)

Contents

Installation	3
Location and function of controls	4
Remote control handset	
Battery installation / Top/Back/Side panel	
Basic operation	8
On and off / Programme selection	
Volume adjustment / Quick view	
Mute function / Auto Demonstration	
TV Swivel function / On screen language selection (option)	
On screen menus	9
Menu selection	
Setting up TV stations	10
Auto programme tuning / Manual programme tuning	
Fine Tuning / Programme edit	
Favourite programme / Calling the programme table	
Picture adjustment	15
PSM (Picture Status Memory)	
Picture adjustment / DRP (Digital Reality Picture)	
CSM (Colour Status Memory) / Picture format	
Sound adjustment	17
SSM (Sound Status Memory)	
Sound adjustment / Stereo/Dual reception	
NICAM reception (option) / Sound output selection	
Other functions	19
TV, AV, DVD and PC modes / Auto AV switching	
Child lock / Auto sleep / Sleep timer	
PIP operation (option)	21
On and off / Input mode selection for sub picture	
Swapping between main and sub pictures	
Programme selection for sub picture	
Sub picture size / Sub picture freeze (option)	
Sub picture position change / Programme scan (option)	
Teletext (option)	23
Switch on/off / SIMPLE text / TOP text (option)	
FASTEXT / Special teletext functions	
Connection of external equipment	26
Aerial socket / Euro scart socket	
Audio/Video in sockets	
S-Video/Audio in sockets (S-Video) (option)	
Headphone socket	
Connection of PC	28
PC in socket (D-Sub jack)	
Menu selection / PC Setup	
DVD Operation	31
Notes on discs / Playing a disc / Playing MP3 discs	
Playing JPEG file / Selecting disc menu	
Selecting title menu / Repeat playback	
A-B repeat playback / Programme playback	
Selecting the camera angle / 3D sound	
Picture size zoom / Selecting a audio language	
Selecting a subtitle language	
Disc menu language selection	
Parental control setting / To change password	
TV Screen / Disc OSD language selection (option)	
Selecting digital audio output	
DRC (Dynamic Range Compression)	
Troubleshooting check list	

Installation

Power

This set operates on an AC mains supply, the voltage is as indicated on the label on the back cover. Never apply DC power to the set. In the event of thunderstorms or powercuts, please pull out the aerial and mains plugs.

- Open the back panel cover.
- After connecting the power cord to the set, connect the power cord to an AC mains.
- Close the back panel cover.

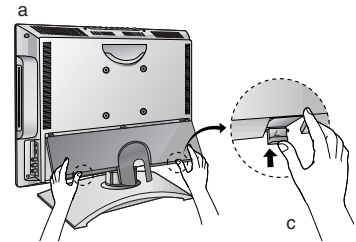

Warning

To prevent fire or shock hazard, do not expose the set to rain or moisture. Do not rub or strike the Active Matrix LCD with anything hard as this may scratch, mar, or damage the Active Matrix LCD permanently.

Service

Never remove the back cover of the set as this can expose you to high voltage and other hazards. If the set does not operate properly, unplug it and call your dealer.

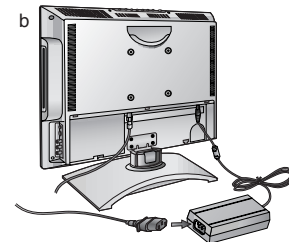

Aerial

Connect the aerial cable to the socket marked $75\ \Omega$ on the back. For the best reception an outdoor aerial should be used.

Location

Position your set so that no bright light or sunlight falls directly onto the screen. Care should be taken not to expose the set to any unnecessary vibration, moisture, dust or heat. Also ensure that the set is placed in a position to allow a free flow of air. Do not cover the ventilation openings on the back cover.

This standing angle can be adjusted as shown in pictures.

When you install the set to use the wall mounting bracket (optional parts), fix it carefully so as not to drop. The set has Kensington Security System Connector on the back panel. Connect the Kensington Security system cable (not supplied).

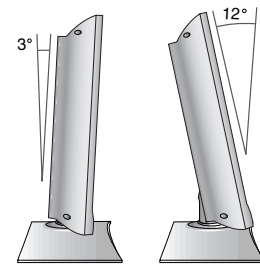

Cleaning

Unplug the set before cleaning the face of the LCD Screen. Dust the set by wiping the screen and the cabinet with a soft, clean cloth. If the screen requires additional cleaning, use a clean, damp cloth. Do not use liquid cleaners or aerosol cleaners.

Manufactured under license from Dolby Laboratories. "Dolby" and the double-D symbol are trademarks of Dolby Laboratories.

Location and function of controls

All the functions can be controlled with the remote control handset. Some functions can also be adjusted with the buttons on the front panel of the set. Only the remote control handset supplied will operate this set.

Remote control handset

Before you use the remote control handset, please install the batteries. See the next page.

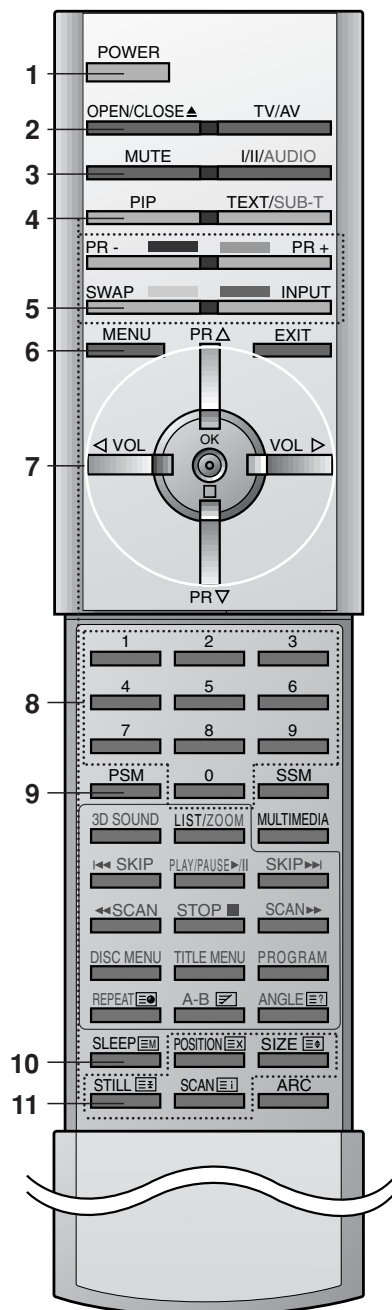

1. **POWER**
switches the set on from standby or off to standby.
2. **OPEN/CLOSE**
Open or close the disc tray.
3. **MUTE**
switches the sound on or off.
4. **PIP BUTTONS (option)**
PIP
switches the sub picture on or off.
PR +/-
selects a programme for the sub picture.
SWAP
alternates between main and sub picture.
INPUT
selects the input mode for the sub picture.
SIZE
adjusts the sub picture size.
STILL (option)
freezes motion of the sub picture.
POSITION
relocates the sub picture in up/down or left/right direction.
SCAN
switches on the programme scan mode through 3/12 sub pictures and 9 main pictures.
5. **SWAP**
returns to the previously viewed programme.
selects a favourite programme.
6. **MENU**
selects a menu.
7. **▲ / ▼ (Programme Up/Down)**
selects a programme or a menu item.
switches the set on from standby.
◀ / ▶ (Volume Up/Down)
adjusts the volume.
adjusts menu settings.
OK
accepts your selection or displays the current mode.
8. **NUMBER BUTTONS**
switches the set on from standby and selects a programme.
9. **PSM (Picture Status Memory)**
recalls your preferred picture setting.
10. **SLEEP**
sets the sleep timer.
11. **STILL (option)**
freezes motion of the picture.

Location and function of controls

- 12. TV/AV**
selects the remote operating mode.
clears the menu from the screen.
switches the set on from standby.
- 13. I/II/AUDIO (option)**
selects the language during dual language broadcast.
selects the sound output (option).
changes the AUDIO status during DVD playback.
- 14. TELETEXT BUTTONS/SUB-T (option)**
These buttons are used for teletext.
For further details, see the 'Teletext' section.
changes the subtitle language during DVD playback.
- 15. EXIT**
exits from each mode.
- 16. SSM (Sound Status Memory)**
recalls your preferred sound setting.
- 17. MULTIMEDIA**
selects DVD or PC monitor mode.
clears the menu from the screen.
switches the set on from standby.
- 18. LIST/ZOOM (option)**
displays the programme table.
changes the picture size during DVD playback.
- 19. DVD BUTTONS**
controls a LG DVD player.
For further details, see the 'DVD Operation' section.

- 20. ARC**
select your desired picture format.

Note : In teletext mode, the **PR +/-**, **SWAP** and **INPUT** buttons are used for teletext function.

Battery installation

The remote control handset is powered by two AAA type batteries. To load the batteries, turn the remote control handset over and open the battery compartment. Install two batteries as indicated by the polarity symbols (+ and -) marked inside the compartment.

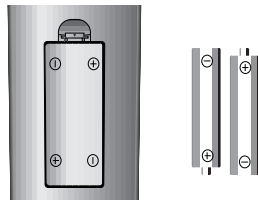

Note : To avoid damage from possible battery leakage, remove the batteries if you do not plan to use the remote control handset for an extended period of time.

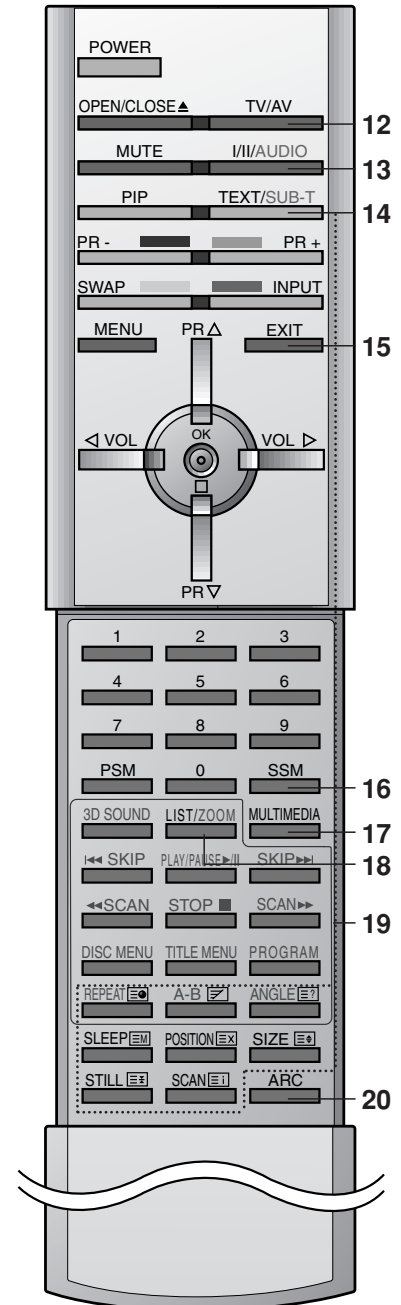

Location and function of controls

Top panel

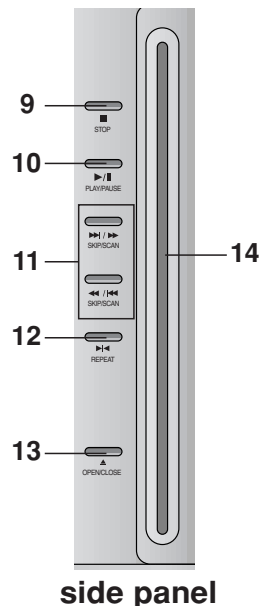
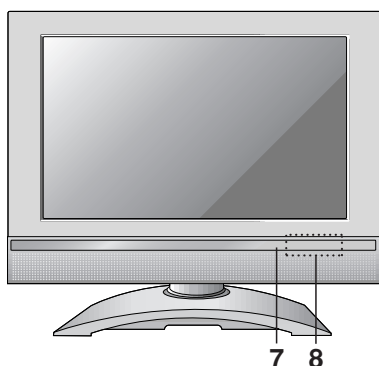
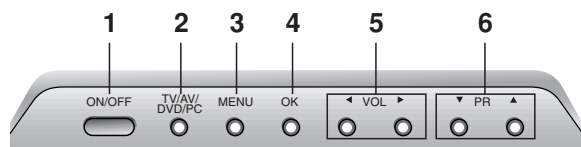

1. **ON/OFF (⏻/⏻)**
switches the set on from standby or off to standby.
Note : Power line lives even when the power is off.
2. **TV/AV//DVD/PC**
selects the remote operating mode.
clears the menu from the screen.
switches the set on from standby.
3. **MENU**
selects a menu.
4. **OK**
accepts your selection or displays the current mode.
5. **◀ / ▶ (Volume Up/Down)**
adjusts the volume.
adjusts menu settings.
6. **▲ / ▼ (Programme Up/Down)**
selects a programme or a menu item.
switches the set on from standby.
7. **REMOTE CONTROL SENSOR**
8. **LED (Light Emitting Diode) DISPLAY**
illuminates brightly when the set is switched on.
⏻ : POWER/STANDBY indicator
MONO : MONO indicator
((S T)) : STEREO indicator
DUAL : DUAL indicator
DPM : DPM indicator
9. **STOP**
Stops playback.
10. **PLAY/PAUSE**
Start or pause playback.
11. **SKIP/SCAN**
Starts playback from the selected chapter or track.
12. **REPEAT**
Repeat playback.
13. **OPEN/CLOSE**
Open or close the disc tray.
Note : When DISC TRAY doesn't work, press the **OPEN/CLOSE** button on the side panel for a moment.
14. **DISC TRAY**
Place a disc on the disc tray.
Note : Insert a disc after facing a logo-printed side to front. See a figure.

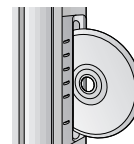

Location and function of controls

Back panel

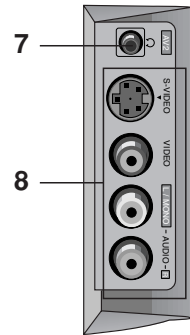
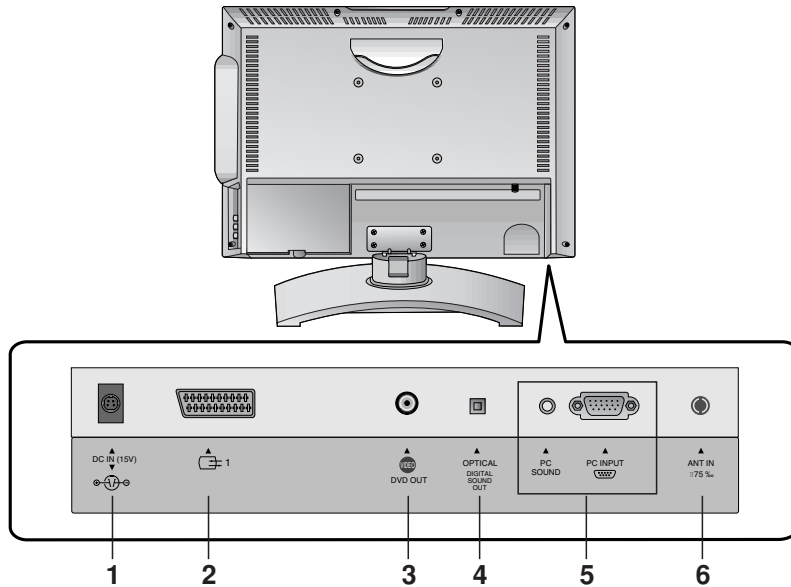

Side panel

1. **DC 15V INPUT SOCKET**
2. **EURO SCART SOCKET (AV1)**
3. **DVD VIDEO OUT SOCKET**
4. **DVD DIGITAL SOUND OUT SOCKET**
Connect to digital audio from various types of equipment.
5. **PC/SOUND INPUT SOCKETS**
Connect the monitor output socket of the PERSONAL COMPUTER to this socket.
6. **AERIAL SOCKET**
7. **HEADPHONE SOCKET**
Connect the headphone plug to this socket.
8. **AUDIO/VIDEO IN SOCKETS (AV2)**
Connect the audio/video out sockets of external equipment to these sockets.
S-VIDEO/AUDIO IN SOCKETS (S-VIDEO)
Connect the video out socket of an S-VIDEO VCR to the **S-VIDEO** socket.
Connects the audio out sockets of the S-VIDEO VCR to the audio sockets as in **AV2**.

Basic operation

On and off

1. Press the **POWER**, **▲ / ▼**, **TV/AV**, **MULTIMEDIA** or **NUMBER** buttons to switch it on fully.
2. Press the **POWER** button. The set reverts to standby mode.
3. Pull out mains plugs to switch the set off.

Note : If, while the set is switched on, the mains plug is disconnected the set will switch to standby or power on when the mains plug is replaced in the mains power socket.

Programme selection

You can select a programme number with the **▲ / ▼** or **NUMBER** buttons.

Volume adjustment

Press the **◀ / ▶** button to adjust the volume.

Quick view

Press the **SWAP** button to view the last programme you were watching.

Note : This function works only when **Favourite programme** is set to **Off**. Otherwise each press of this button will select a stored favorite programme.

Mute function

Press the **MUTE** button. The sound is switched off and the display  appears.

You can cancel it by pressing the **MUTE**, **◀ / ▶**, **I/II** or **SSM** button.

Auto Demonstration

To review all the menus programmed in the set, press the **OK** button of the top panel controls for about 10 seconds. To stop auto demonstration, press any button of the top panel controls and the **POWER** button of the remote control.

TV Swivel function

You can manually turn TV set at left or right direction by 25 degrees, so that the watching degree is suitable for your position.

On screen language selection (option)

The menu can be displayed on the screen in your desired language. First select your language.

1. Press the **MENU** button and then **▲ / ▼** button to select the Special menu.
2. Press the **▶** button and then **▲ / ▼** button to select **Language**.
3. Press the **◀ / ▶** button to select your desired language. All the on screen displays will appear in the selected language. Press the **OK** button.
4. Press the **EXIT** button to return to normal TV viewing.

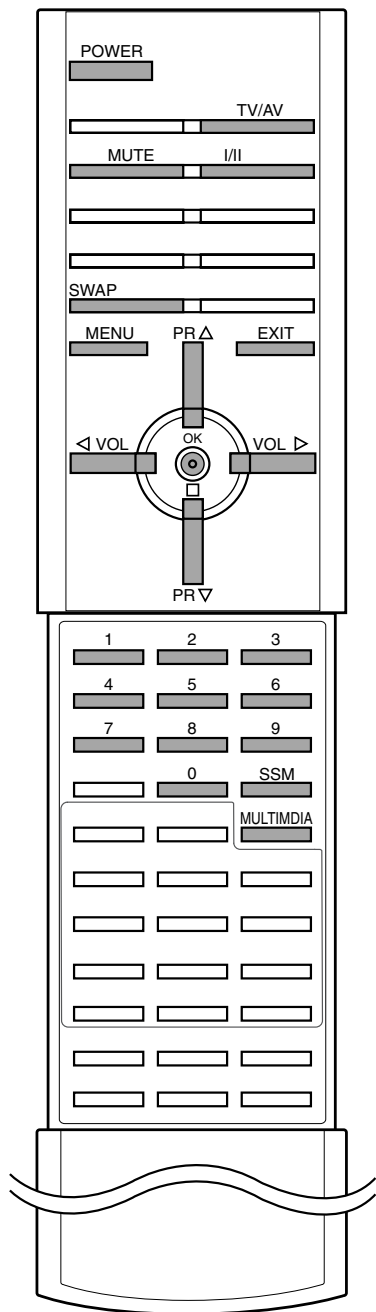

On screen menus

Menu selection

1. Press the **MENU** button and then **▲ / ▼** button to display each menu.
2. Press the **▶** button and then **▲ / ▼** button to select a menu item.
3. Change the setting of an item in the sub or pull-down menu with **◀ / ▶** button.

You can move to the higher level menu by pressing the **OK** button and to move to the lower level menu by pressing the **MENU** button.

Note :

- a. In the PC mode, the Station menu is not displayed.
- b. In the TV/AV mode, the RGB-PC menu is not displayed.
- c. In the teletext mode, menus are not displayed.
- d. On some models, the **Language** will not be displayed.

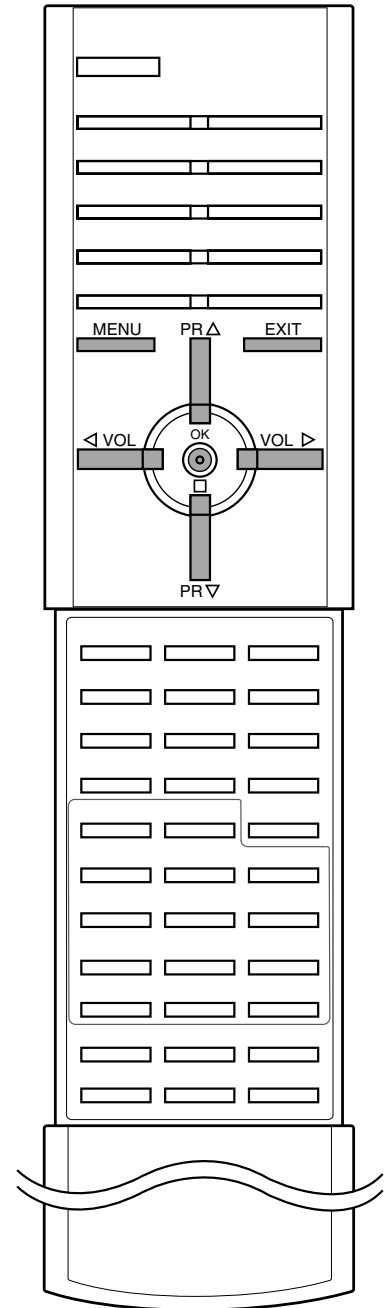
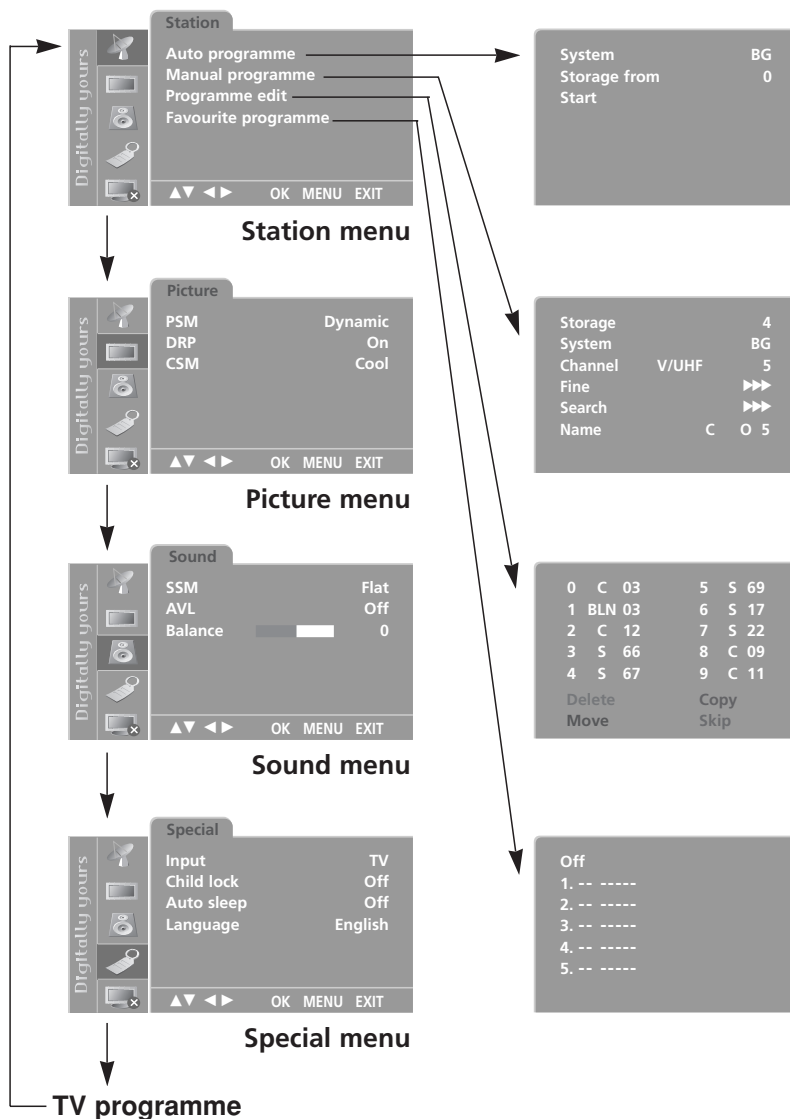

Setting up TV stations

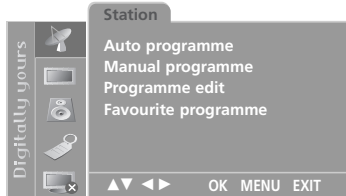

Up to 100 TV stations can be stored by programme numbers (0 to 99). Once you have preset the stations, you will be able to use the ▲ / ▼ or NUMBER buttons to scan the stations you have programmed. Stations can be tuned using automatic or manual modes.

Auto programme tuning

All stations that can be received are stored by this method. It is recommended that you use auto programme during installation of this set.

1. Press the **MENU** button and then ▲ / ▼ button to select the **Station** menu.
2. Press the ► button and then ▲ / ▼ button to select **Auto programme**.

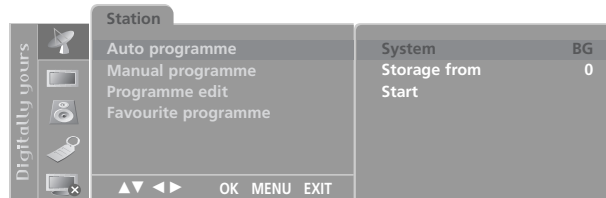

3. Press the ► button. Select a TV system with the ◀ / ► button on the **System** menu;
 - L** : SECAM L/L' (France)
 - BG** : PAL B/G, SECAM B/G (Europe/East Europe)
 - I** : PAL I/II (U.K./Ireland)
 - DK** : PAL D/K, SECAM D/K (East Europe)
4. Press the ▲ / ▼ button to select **Storage from**.
5. Select the beginning programme number with the ◀ / ► button or NUMBER buttons on the **Storage from** pull-down menu. Any number under 10 is entered with a numeric '0' in front of it, i.e. '05' for 5.
6. Press the ▲ / ▼ button to select **Start**.
7. Press the ► button to begin auto programming.

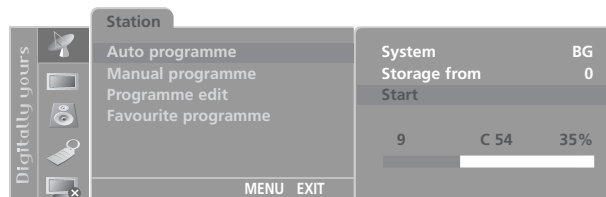

All receivable stations are stored. The station name is stored for stations which broadcast VPS (Video Programme Service), PDC (Programme Delivery Control) or TELETEXT data. If no station name can be assigned to a station, the channel number is assigned and stored as **C** (V/UHF 01-69) or **S** (Cable 01-47), followed by a number.

To stop auto programming, press the **MENU** button. When auto programming is completed, the **Programme edit** menu appears on the screen. See the 'Programme edit' section to edit the stored programme.

8. Press the **EXIT** button to return to normal TV viewing.

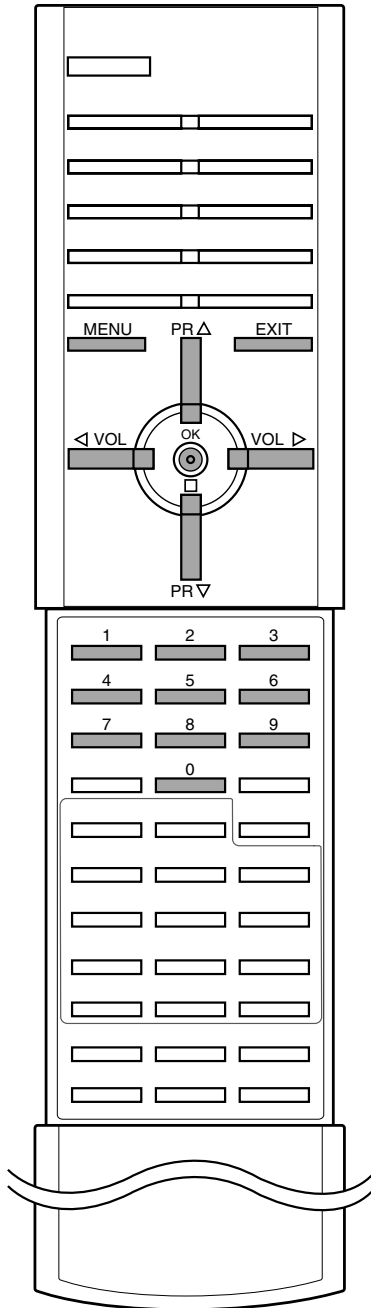

Setting up TV stations

Manual programme tuning

Manual programme lets you manually tune and arrange the stations in whatever order you desire. Also you can assign a station name with five characters to each programme number.

1. Press the **MENU** button and then **▲ / ▼** button to select the Station menu.
2. Press the **▶** button and then **▲ / ▼** button to select **Manual programme**.
3. Press the **▶** button and then **▲ / ▼** button to select **Storage**.

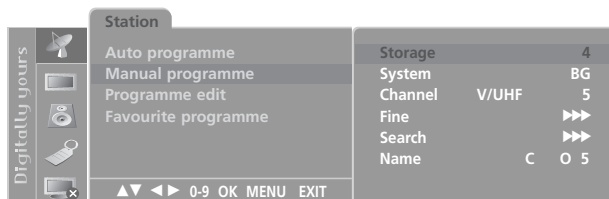

4. Select the desired programme number (0 to 99) with the **◀ / ▶** button or **NUMBER** buttons on the **Storage** menu. Any number under 10 is entered with a numeric '0' in front of it, i.e. '05' for 5.
5. Press the **▲ / ▼** button to select **System**.
6. Select a TV system with the **◀ / ▶** button on the **System** menu;
 - L** : SECAM L/L' (France)
 - BG** : PAL B/G, SECAM B/G (Europe/East Europe)
 - I** : PAL I/II (U.K./Ireland)
 - DK** : PAL D/K, SECAM D/K (East Europe)
7. Press the **▲ / ▼** button to select **Channel**.
8. Press the **◀ / ▶** button to select **V/UHF** or **Cable** on the **Channel** menu.

If possible, select the channel number directly with the number buttons. Any number under 10 is entered with a numeric '0' in front of it, i.e. '05' for 5.
9. Press the **▲ / ▼** button to select **Search**.
10. Press the **◀ / ▶** button to commence searching on the **Search** pull-down menu. If a station is found the search will stop.
11. Press the **OK** button to store it.

The display **Stored** will appear.

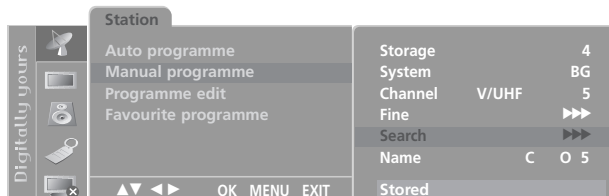

12. To store another station, repeat steps 3 to 11.
13. Press the **EXIT** button to return to normal TV viewing.

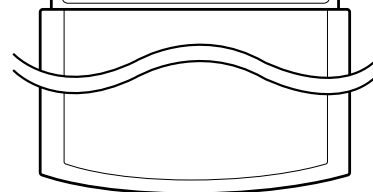
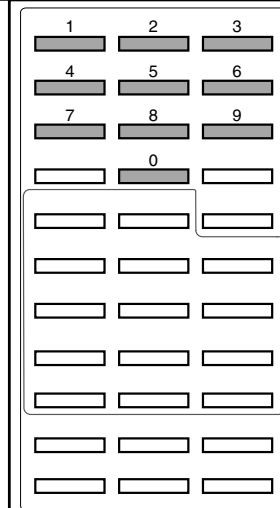
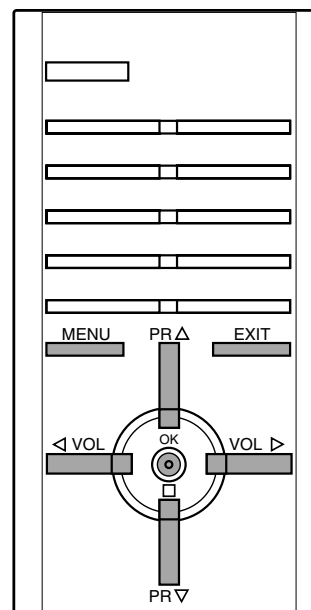

Setting up TV stations

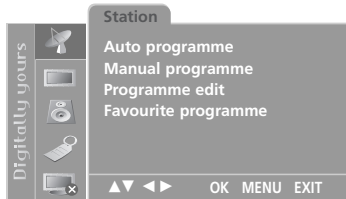

Assigning a station name

1. Repeat the 'Manual programme tuning' steps 1 to 2.
2. Press the ► button and then ▲ / ▼ button to select **Name**.
3. Press the ► button and then ▲ / ▼ button to use a blank, +, -, the numeric 0 to 9 and the alphabet A to Z.
4. Select the position by pressing the ◀ / ▶ button and then make your choice of the second character, and so on.
5. Press the **OK** button to store it. The display **Stored** will appear.
6. Press the **EXIT** button to return to normal TV viewing.

Fine tuning

Normally fine tuning is only necessary if reception is poor.

1. Repeat the 'Manual programme tuning' steps 1 to 2.
2. Press the ► button and then ▲ / ▼ button to select **Fine**.
3. Press the ◀ / ▶ button to fine tune for the best picture and sound on the **Fine** menu.
4. Press the **OK** button to store it.

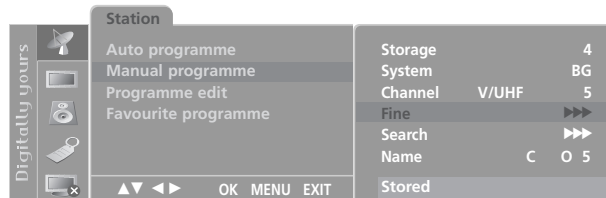

5. Press the **EXIT** button to return to normal TV viewing. The finely tuned programme will be indicated by a yellow number during programme selection.

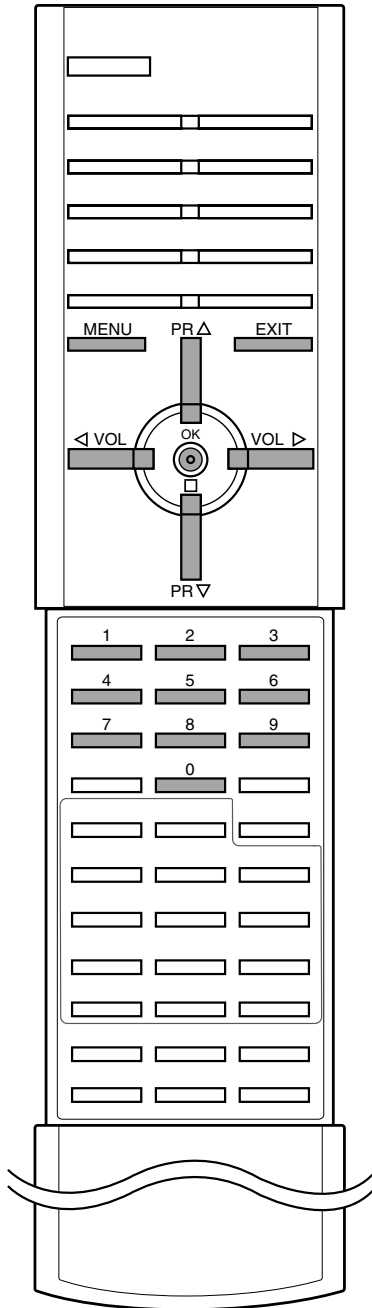

Setting up TV stations

Programme edit

This function enables you to delete or skip the stored programmes. Also you can move some stations to other programme numbers or insert a blank station data into the selected programme number.

1. Press the **MENU** button and then **▲ / ▼** button to select the Station menu.
2. Press the **▶** button and then **▲ / ▼** button to select **Programme edit**.
3. Press the **▶** button to display the **Programme edit** menu.

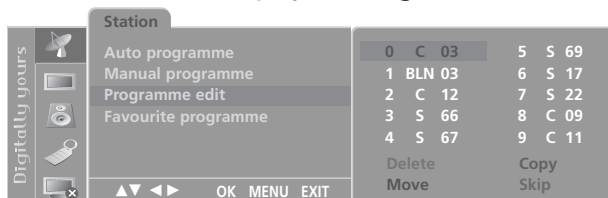

Deleting a programme

1. Select a programme to be deleted with the **▲ / ▼** or **◀ / ▶** button.
 2. Press the **RED** button twice.
- The selected programme is deleted, all the following programmes are shifted up one position.

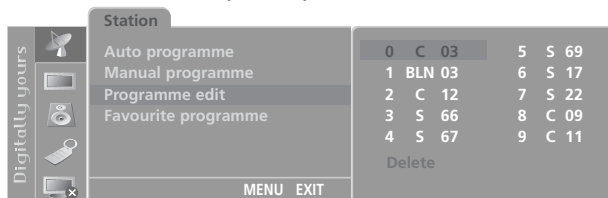

Copying a programme

1. Select a programme to be copied with the **▲ / ▼** or **◀ / ▶** button.
 2. Press the **GREEN** button.
- All the following programmes are shifted down one position.

Moving a programme

1. Select a programme to be moved with the **▲ / ▼** or **◀ / ▶** button.
2. Press the **YELLOW** button.
3. Move the programme to the desired programme number with the **▲ / ▼** or **◀ / ▶** button.
4. Press the **YELLOW** button again to release this function.

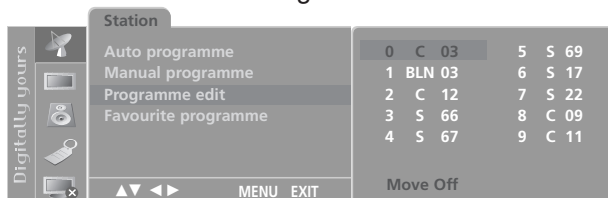

Skipping a programme number

1. Select a programme number to be skipped with the **▲ / ▼** or **◀ / ▶** button.
 2. Press the **BLUE** button. The skipped programme turns to blue.
 3. Press the **BLUE** button again to release the skipped programme.
- When a programme number is skipped it means that you will be unable to select it using the **▲ / ▼** button during normal TV viewing. If you want to select the skipped programme, directly enter the programme number with the **NUMBER** buttons or select it in the programme edit or table menu.

Press the **EXIT** button to return to normal TV viewing.

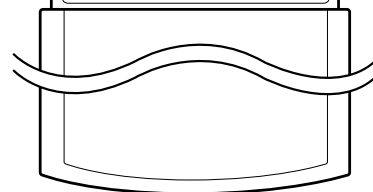
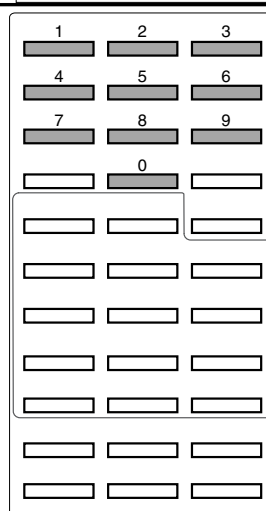
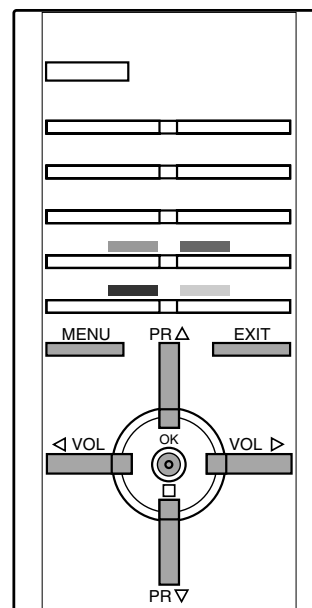

Setting up TV stations



Favourite programme

This function lets you select your favourite programmes directly.

1. Press the **MENU** button and then **▲ / ▼** to select the Station menu.
2. Press the **▶** button and then **▲ / ▼** to select **Favourite programme**.

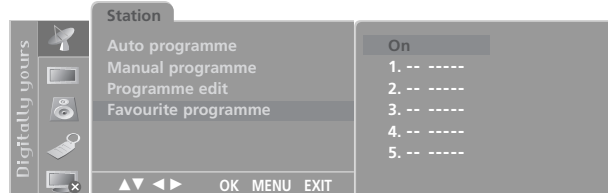

3. Press the **▶** button and then **◀ / ▶** button to select **On** or **Off**.
4. Press the **▲ / ▼** button to select **-- -----**.
5. Select a desired programme with the **◀ / ▶** button or **NUMBER** buttons. Any number under 10 is entered with a numeric **'0'** in front of it, i.e. **'05'** for 5.
6. To store another programme, repeat steps 4 to 5.
7. Press the **EXIT** button to return to normal TV viewing.

Repeatedly press the **SWAP** button to select stored favourite programmes.

Calling the programme table

You can check the programmes stored in the memory by displaying the programme table.

Displaying programme table

Press the **LIST** button to display the **Programme table** menu. The programme table appears on the screen. One programme table contains ten programmes as below.

0	C	03	5	S	69
1	BLN	03	6	S	17
2	C	12	7	S	22
3	S	66	8	C	09
4	S	67	9	C	11

Note :

- a. You may find some blue programmes. They have been set up to be skipped by auto programming or in the programme edit mode.
- b. Some programmes with the channel number shown in the programme table indicate there is no station name assigned.

Selecting a programme in the programme table

Select a programme with the **▲ / ▼** or **◀ / ▶** button. Then press the **OK** button. The set switches to the chosen programme number.

Paging through a programme table

There are 10 programme table pages in which contain 100 programmes. Pressing the **▲ / ▼** or **◀ / ▶** button repeatedly turns the pages.

Press the **LIST** button to return to normal TV viewing.

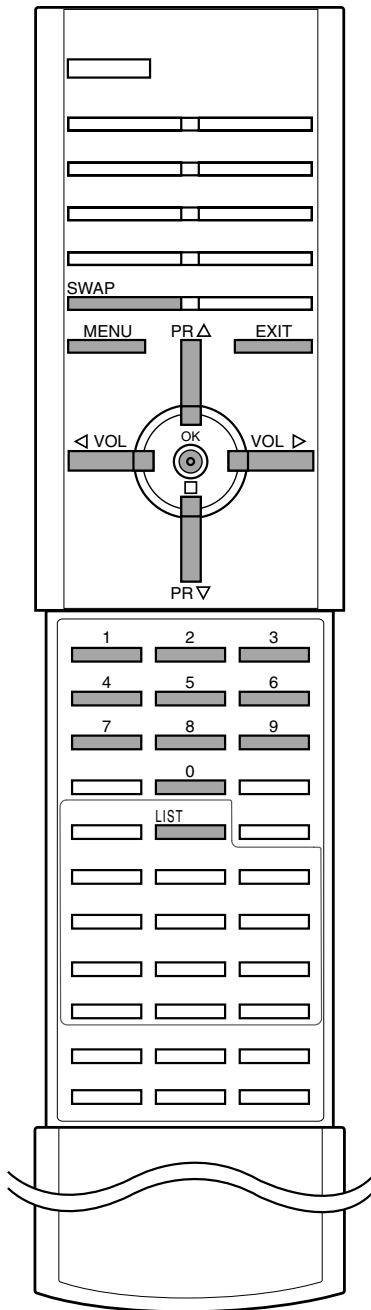

Picture adjustment

PSM (Picture Status Memory)

1. Press the **MENU** button and then **▲ / ▼** button to select the Picture menu.
2. Press the **▶** button and then **▲ / ▼** button to select **PSM**.
3. Press the **◀ / ▶** button to select a picture setting on the **PSM** menu.

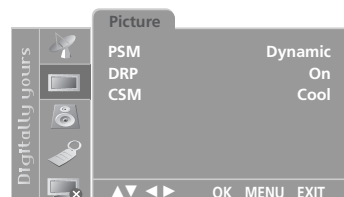
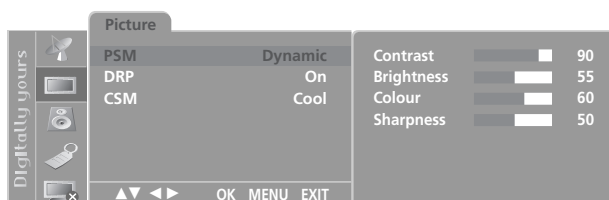

4. Press the **EXIT** button to return to normal TV viewing.

You can also recall a desired picture (**Dynamic, Standard, Mild, Game** or **User**) with **PSM** button on the remote control. The picture **Dynamic, Standard, Mild** and **Game** are programmed for optimum picture reproduction at the factory and cannot be changed.

Picture adjustment

You can adjust picture contrast, brightness, colour intensity, sharpness and tint (NTSC AV only) to the levels you prefer.

1. Press the **MENU** button and then **▲ / ▼** button to select the Picture menu.
2. Press the **▶** button and then **▲ / ▼** button to select **PSM**.
3. Press the **OK** button and then **◀ / ▶** button to make appropriate adjustments on each sub menu.

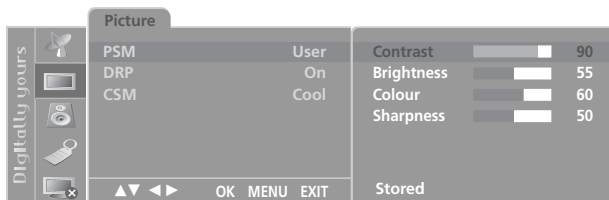

You can also select other **User** items directly with **▲ / ▼** button and adjust them with **◀ / ▶** button.

4. Press the **OK** button to store it for the picture **User**. The display **Stored** will appear.
5. Press the **EXIT** button to return to normal TV viewing.

Note : Only **Contrast** and **Brightness** are displayed in **PC** mode.

DRP (Digital Reality Picture)

DRP improves image outlines in dark screens.

1. Press the **MENU** button and then **▲ / ▼** button to select the Picture menu.
2. Press the **▶** button and then **▲ / ▼** button to select **DRP**.
3. Press **◀ / ▶** button to select **On** or **Off** on the **DRP** menu.
4. Press the **OK** button.
5. Press the **EXIT** button to return to normal TV viewing.

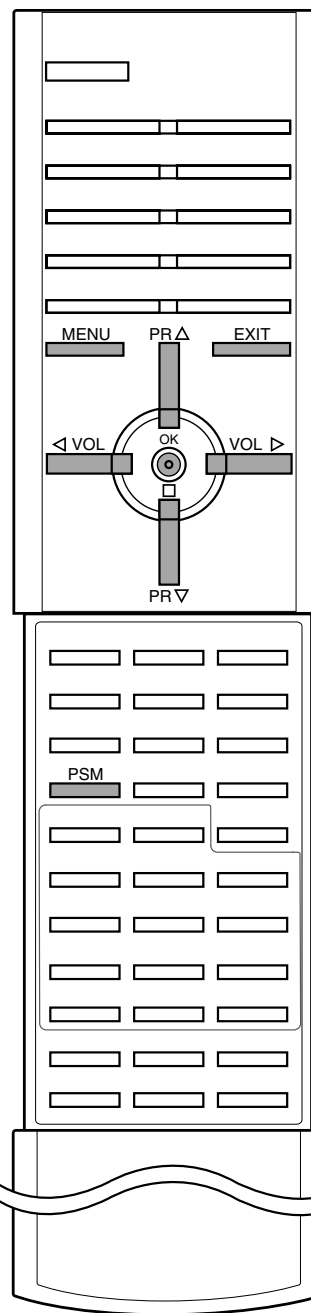

Picture adjustment

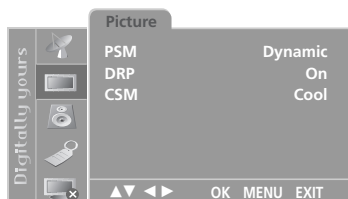

CSM (Colour Status Memory)

You can adjust the temperature of R, G, B (Red, Green, Blue) to the levels you prefer.

1. Press the **MENU** button and then **▲ / ▼** button to select the Picture menu.
2. Press the **▶** button and then **▲ / ▼** button to select **CSM**.
3. Press the **OK** button.

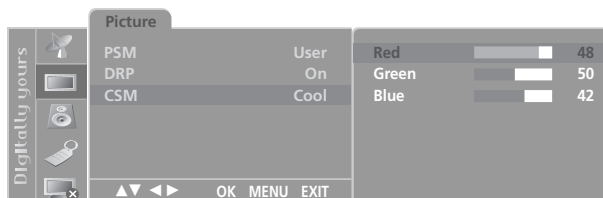

4. Repeat the 'Picture adjustment' steps 3 to 5.

The temperature **Cool**, **Normal** and **Warm** are programmed for optimum picture reproduction at the factory and can not be changed.

Picture format

You can watch TV in various picture formats; Wide, 14:9, Zoom, Auto, 4:3.

Repeatedly press the **ARC** button to select your desired picture format.

Wide

You can enjoy the cinema (the picture format of 16:9) or general TV programme through the 16:9 mode.

The screen 16:9 is viewed just like that but the screen 4:3 is magnified to the left and right so that the screen 16:9 is full.

14:9

You can enjoy the picture format of 14:9 or general TV programme through the 14:9 mode.

The screen 14:9 is viewed just like that the screen 4:3 is magnified to the upper / lower and left / right.

Zoom

You can enjoy the cinema in a vast screen through the Zoom mode. The screen 4:3 is magnified to the upper / lower and left / right sides so that the screen 16:9 is full. The bottom and top of the picture may be lost.

Auto

When your set receives the wide screen signal, it will be automatically changed to the picture format to be sent.

4:3

This picture format is 4 to 3 of general TV.

Note :

- a. In the double window and scan mode, ARC function isn't available.
- b. You are available to Wide and 4:3 in PC mode.
- c. You are available to Wide, 14:9, Zoom and 4:3 in DVD mode.

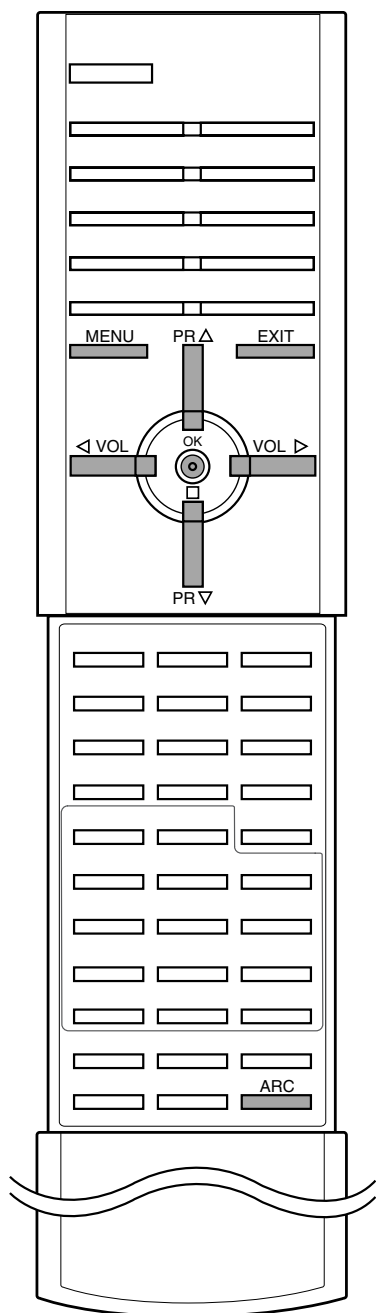

Sound adjustment

SSM (Sound Status Memory)

You can select your preferred sound setting; Flat, Music, Movie or Speech and you can also adjust the sound frequency of the equalizer.

1. Press the **MENU** button and then **▲ / ▼** button to select the Sound menu.
2. Press the **▶** button and then **▲ / ▼** button to select **SSM**.

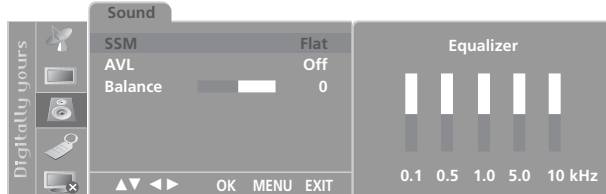

3. Press the **◀ / ▶** button to select a sound setting on the **SSM** menu.
 - Sound Frequency Adjustment**
 - a. Press the **OK** button in **SSM**.

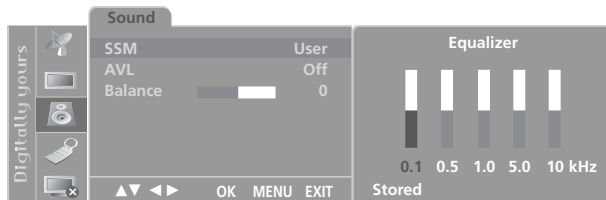

- b. Select a sound band by pressing the **◀ / ▶** button.
- c. Make appropriate sound level with the **▲ / ▼** button.
- d. Press the **OK** button to store it for the sound **User**.
The display **Stored** will appear.

Press the **EXIT** button to return to normal TV viewing.

You can also recall a desired sound setting (**Flat**, **Music**, **Movie**, **Speech** or **User**) with **SSM** button on the remote control. The sound settings **Flat**, **Music**, **Movie** and **Speech** are programmed for optimum sound reproduction at the factory and cannot be changed.

Note : If you press the **SSM** button after making appropriate adjustment on the **User** sub menu, the display **User** automatically appears even though you have already set a factory preset setting; **Flat**, **Music**, **Movie** or **Speech**.

Sound adjustment

You can adjust balance, AVL (Auto Volume Leveler). AVL automatically keeps on an equal volume level even if you change programmes.

1. Press the **MENU** button and then **▲ / ▼** button to select the Sound menu.
2. Press the **▶** button and then **▲ / ▼** button to select the desired sound item; **AVL** or **Balance**.

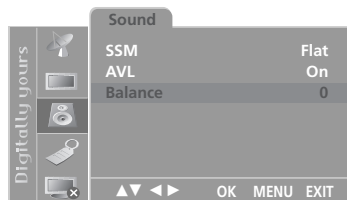

3. Make desired adjustment with the **◀ / ▶** and then press the **OK** button.
4. Press the **EXIT** button to return to normal TV viewing.

Note : In **PC** mode, you can select Sound select menu in **PIP**, **DW1**, **DW2**, **POP1** mode.

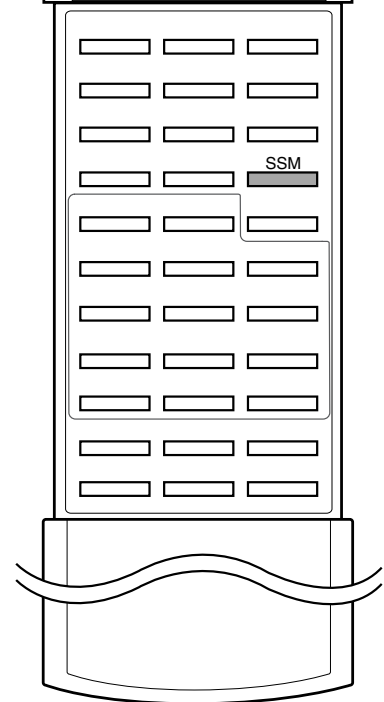
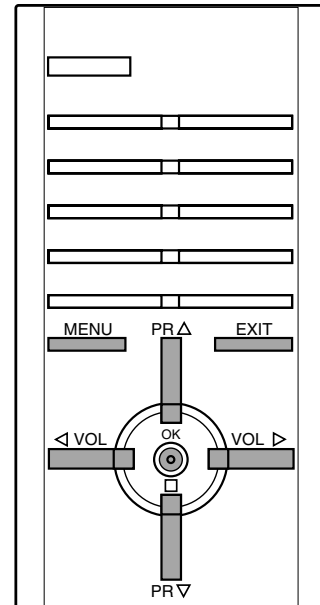
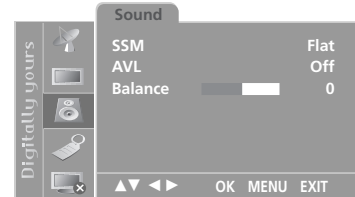

Sound adjustment

Stereo/Dual reception

When a programme is selected, the sound information for the station appears after the programme number and station name disappear.

Broadcast	On Screen Display
Mono	MONO
Stereo	STEREO
Dual	DUAL I

Mono sound selection

In stereo reception if the stereo signal is weak, you can switch to mono by pressing the **I/II** button twice. In mono reception the depth of sound is improved. To switch back to stereo, press the **I/II** button twice again.

Language selection for dual language broadcast

If a programme is received in two languages (dual language), you can switch to **DUAL I**, **DUAL II** or **DUAL I+II** by pressing the **I/II** button repeatedly.

DUAL I sends the primary broadcast language to the loudspeakers.

DUAL II sends the secondary broadcast language to the loudspeakers.

DUAL I+II sends a separate language to each loudspeaker.

NICAM reception (option)

If your set is equipped with the receiver for NICAM reception, the high quality NICAM (Near Instantaneous Companding Audio Multiplex) digital sound can be received.

Sound output can be selected according to the type of received broadcast as follows by pressing the **I/II** button repeatedly.

1. When NICAM mono is received, you can select **NICAM MONO** or **FM MONO**.
2. When NICAM stereo is received, you can select **NICAM STEREO** or **FM MONO**. If the stereo signal is weak, switch to **FM mono**.
3. When NICAM dual is received, you can select **NICAM DUAL I**, **NICAM DUAL II** or **NICAM DUAL I+II** or **MONO**. When **FM mono** is selected the display **MONO** appears on the screen.

Sound output selection

In AV mode, you can select output sound for the left and right loudspeakers.

Repeatedly press the **I/II** button to select the sound output.

L+R : Audio signal from audio L input is sent to left loud-speaker and audio signal from audio R input is sent to right loud-speaker.

L+L : Audio signal from audio L input is sent to left and right loudspeakers.

R+R : Audio signal from audio R input is sent to left and right loudspeakers.

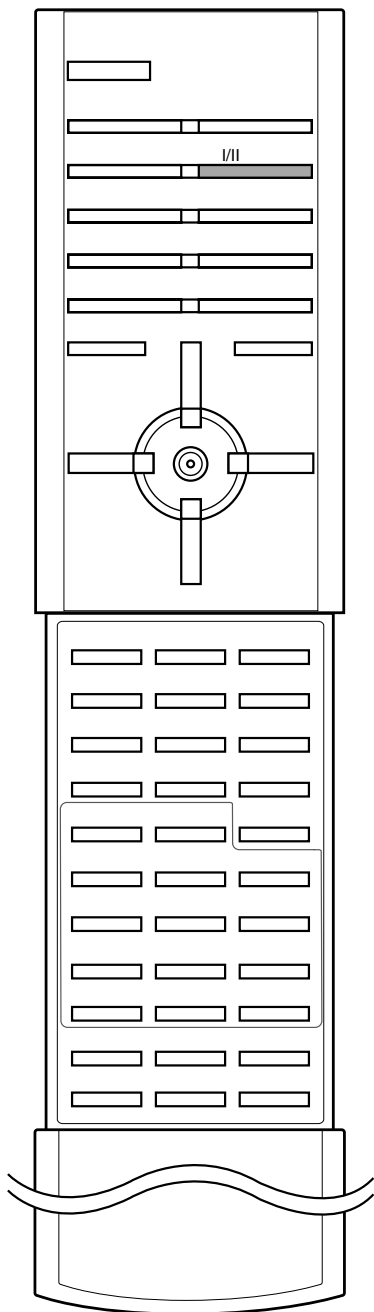

Other functions

TV, AV, DVD and PC modes

Inputs can be set for TV, AV, DVD or RGB-PC mode. AV mode is used when a video cassette recorder (VCR), or other equipment is connected to the set.

Note : When a VCR is connected via the aerial socket the set is used in TV mode. See the 'Connection of external equipment' section.

1. Press the **MENU** button and then **▲ / ▼** button to select the Special menu.
2. Press the **▶** button and then **▲ / ▼** button to select **Input**.
3. Press the **◀ / ▶** button to select **TV, AV1, AV2, S-Video, DVD** or **RGB-PC**.



The AV, DVD and RGB-PC modes are :

AV 1 : VCR connected to the Euro scart socket of the set

AV 2 : VCR connected to the **AV2** of the set

S-Video : VCR connected to the **S-Video** of the set

DVD : DVD mode

RGB-PC : PERSONAL COMPUTER connected to the PC socket of the set

4. Press the **EXIT** button to return to normal TV viewing.

Alternatively you can select the TV, AV, DVD or RGB-PC mode by pressing the **TV/AV** button.

In AV or RGB-PC mode, to return to TV mode, press the **▲ / ▼** or **NUMBER** buttons.

Auto AV switching

If your VCR outputs an AV switching voltage when connected to the Euro scart socket, the set will switch to **AV1** mode automatically. But if you want to keep on watching TV mode, press the **▲ / ▼** or **NUMBER** buttons.

Press the **TV/AV** button to return to AV modes.

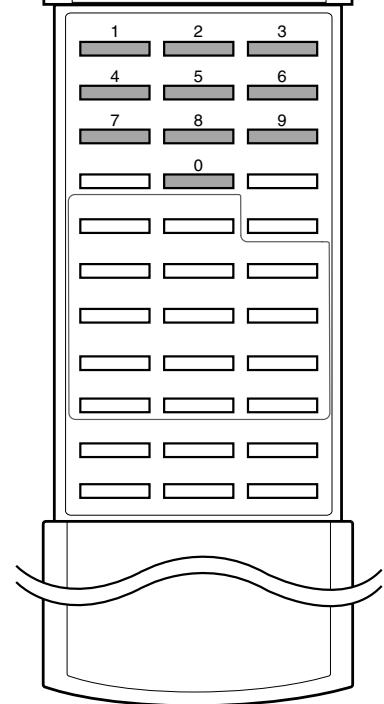
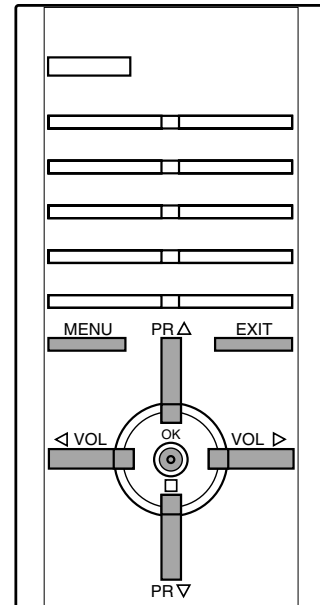

Other functions

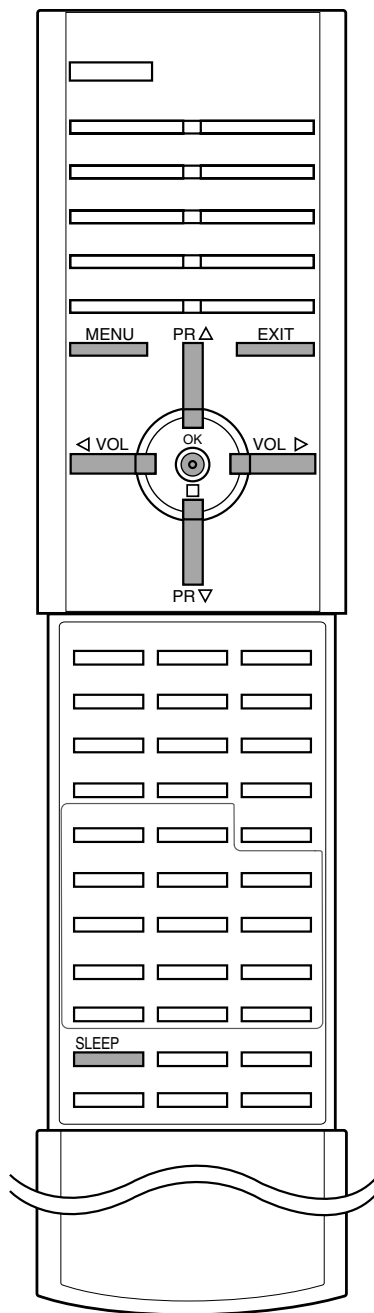

Child lock

The TV can be set so that the remote control handset is needed to control it. This feature can be used to prevent unauthorized viewing.

1. Press the **MENU** button and then ▲ / ▼ button to select the Special menu.
2. Press the ► button and then ▲ / ▼ button to select **Child lock**.
3. Press the ◀ / ▶ button to select **On** or **Off** on the **Child lock** menu.
4. Press the **EXIT** button to return to normal TV viewing.

With the lock on, the display **Child lock on** appears on the screen if any button on the side panel is pressed while viewing the TV.

Note : The display **Child lock on** will not appear on the screen if any button on the side panel is pressed while displaying the menus.

Auto sleep

If you select **On** on the **Auto sleep** menu, the set will automatically switch itself to standby mode approximately ten minutes after a TV station stops broadcasting.

1. Press the **MENU** button and then ▲ / ▼ button to select the Special menu.
2. Press the ► button and then ▲ / ▼ button to select **Auto sleep**.
3. Press the ◀ / ▶ to select **On** or **Off** on the **Auto sleep** menu.
4. Press the **EXIT** button to return to normal TV viewing.

Sleep timer

You don't have to remember to switch the set off before you go to sleep. The sleep timer automatically switches the set to standby after the preset time has elapsed.

Press the **SLEEP** button to select the number of minutes. The display 'Ⓞ^{zz} ---' will appear on the screen, followed by **10, 20, 30, 60, 90, 120, 180** and **240**. The timer begins to count down from the number of minutes selected.

Note :

- a. To view the remaining sleep time, press the **SLEEP** button once.
- b. To cancel the sleep time, repeatedly press the **SLEEP** button until the display 'Ⓞ^{zz} ---' appears.
- c. When you switch the set off, the set releases the preset sleep time.

PIP operation (option)

Option :

PIP is an optional function, so that only the set with PIP function can operate.

PIP (Picture in Picture) displays a picture within a picture.

Select TV, AV, DVD or PC mode to operate PIP function.

On and off

Press the **PIP** button to switch on the sub picture.

Each time this button is pressed, each mode for the sub picture is displayed as shown below.



Press **EXIT** button to switch it off.

Input mode selection for sub picture (PC mode only)

Press the **INPUT** button to select the input mode for the sub picture.

Each time this button is pressed, each input mode for the sub picture is displayed as shown below.

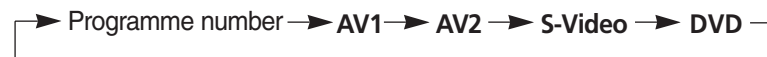

Swapping between main and sub pictures

Press the **SWAP** button to exchange the main and sub pictures.

Programme selection for sub picture

Press the **PR +/-** buttons to select a programme for the sub picture. The selected programme number is displayed just below the programme number of main picture.

Sub picture size

Press the **SIZE** button and then press the **◀ / ▶** button until desired size is achieved. The **SIZE** button doesn't work in DW1, DW2 and POP1 mode.

Sub picture freeze (option)

Press the **STILL** button to freeze motion of the sub picture. Press any button to restore motion.

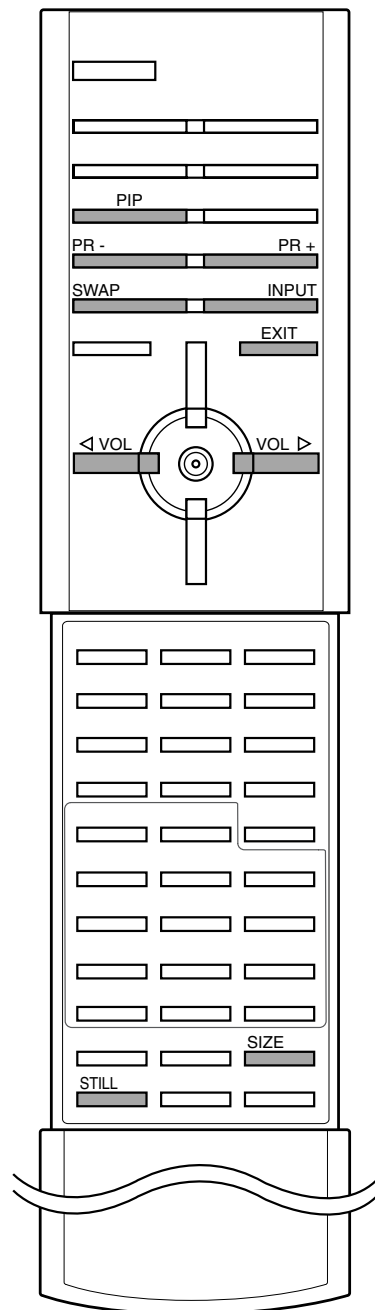

PIP operation (option)

Sub picture position change

Press the **POSITION** button and then press the **▲ / ▼** or **◀ / ▶** button until desired position is achieved. The sub pictures moves up/down or left/right. The **POSITION** button doesn't work in DW1, DW2 and POP1 mode.

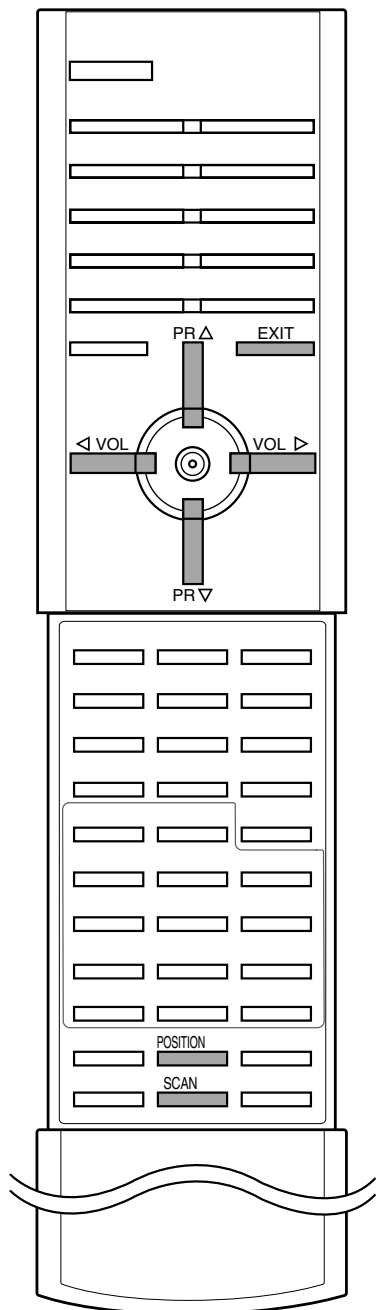

Programme scan (option)

This function enables you to search all the stored stations on 3/12 sub pictures and 9 main pictures and see your favourite station by exchanging the main and sub pictures.

Press the **SCAN** button repeatedly to select POP3/POP12/POP9. The selected sub or main pictures search all the stored stations. Press the **EXIT** button to switch off sub or main pictures.

<PIP/POP Specification>

Condition		PIP mode				
Main picture	PIP	PIP	POP3	POP12	POP9	POP1
PC	RF (TV)	RF (TV)	RF (TV) channel scan	RF (TV) channel scan	PC strobe	RF (TV)
PC	AV	AV	AV strobe	AV strobe	PC strobe	AV
PC	DVD	DVD	DVD strobe	DVD strobe	PC strobe	DVD
RF (TV)	PC	PC	PC strobe	PC strobe	RF (TV) channel scan	x
AV	PC	PC	PC strobe	PC strobe	AV strobe	x
DVD	PC	PC	PC strobe	PC strobe	DVD strobe	x

Note : The PIP picture resolution will be decreased by the PIP size.

Teletext (option)

Teletext (or TOP text) is an optional function, therefore only a set with the teletext system can receive the teletext broadcast.

Teletext is a free service broadcast by most TV stations which gives up-to-the-minute information on news, weather, television programmes, share prices and many other topics.

The teletext decoder of this TV can support the SIMPLE, TOP and FASTEXT systems. SIMPLE (standard teletext) consists of a number of pages which are selected by directly entering the corresponding page number. TOP and FASTEXT are more modern methods allowing quick and easy selection of teletext information.

Switch on/off

Press the **TEXT** button to switch to teletext. The initial page or last page appears on the screen.

Two page numbers, TV station name, date and time are displayed on the screen headline. The first page number indicates your selection, while the second shows the current page displayed.

Press the **TEXT** or **EXIT** button to switch off teletext. The previous mode reappears.

SIMPLE text

Page selection

1. Enter the desired page number as a three digit number with the **NUMBER** buttons. If during selection you press a wrong number, you must complete the three digit number and then re-enter the correct page number.
2. The **▲ / ▼** button can be used to select the preceding or following page.

Programming a colour button in LIST mode

If the TV is in SIMPLE text, TOP text or FASTEXT mode, press the **EM** button to switch to LIST mode.

Four teletext page numbers of your choice can be colour coded and easily selected by pressing the corresponding coloured button on the remote control handset.

1. Press a coloured button.
2. Using the **NUMBER** buttons, select the page you wish to programme.
3. Press the **OK** button. Then the selected page is stored as the selected page number by blinking once. From now on, you can select this page with the same coloured button.
4. The three other coloured buttons are programmed in this way.

Note : In PIP of the PC mode, select the sub picture size is **PIP, DW1, DW2, POP1**.

In PIP of the PC mode, the text on the screen may be unstable.

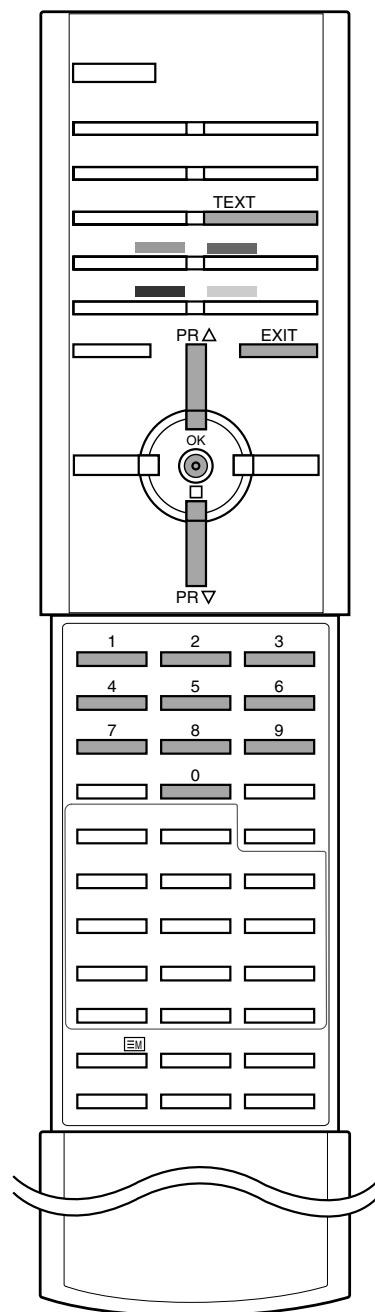

Teletext (option)

TOP text (option)

The user guide displays four fields-red, green, yellow and blue at the bottom of the screen. The yellow field denotes the next group and the blue field indicates the next block.

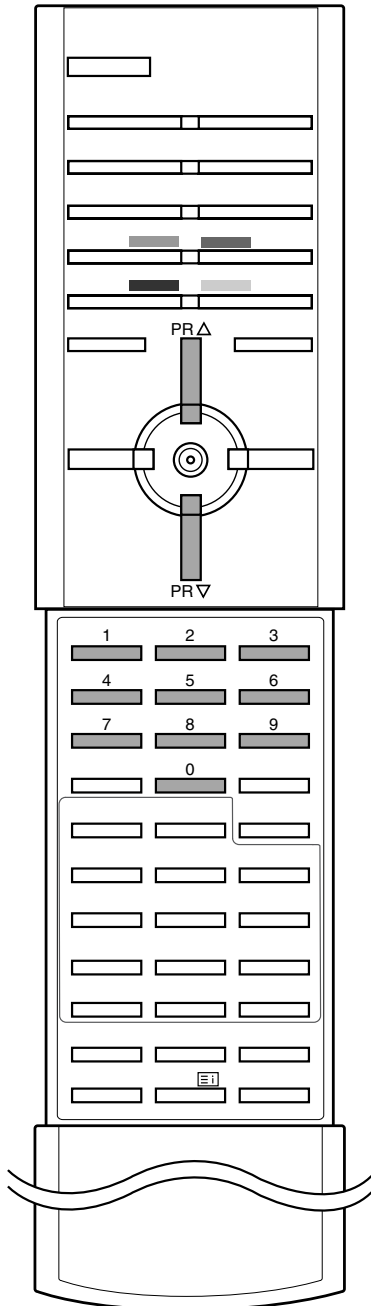

Block / group / page selection

1. With the blue button you can progress from block to block.
2. Use the yellow button to proceed to the next group with automatic overflow to the next block.
3. With the green button you can proceed to the next existing page with automatic overflow to the next group. Alternatively the ▲ button can be used.
4. The red button permits to return to previous selection. Alternatively the ▼ button can be used.

Direct page selection

Corresponding to the SIMPLE teletext mode, you can select a page by entering it as a three digit number using the NUMBER buttons in TOP mode.

FASTTEXT

The teletext pages are colour coded along the bottom of the screen and are selected by pressing the corresponding coloured button.

Page selection

1. Press the  button to select the index page.
2. You can select the pages which are colour coded along the bottom line with the same coloured buttons.
3. Corresponding to the SIMPLE teletext mode, you can select a page by entering its three digit page number with the NUMBER buttons in FASTTEXT mode.
4. The ▲ / ▼ button can be used to select the preceding or following page.

Teletext (option)

Special teletext functions



REVEAL

Press this button to display concealed information, such as solutions of riddles or puzzles.

Press this button again to remove the information from the display.



SIZE

Selects double height text.



Press this button to enlarge the top half of the page.

Press this button again to enlarge the bottom half of the page.

Press this button again to return to the normal display.



UPDATE

Displays the TV picture on the screen while waiting for the new teletext page. The display  will appear at the top left hand corner of the screen. When the updated page is available then display  will change to the page number. Press this button to view the updated teletext page.



HOLD

Stops the automatic page change which will occur if a teletext page consists of 2 or more sub pages. The number of sub pages and the sub page displayed is, usually, shown on the screen below the time. When this button is pressed the stop symbol is displayed at the top left-hand corner of the screen and the automatic page change is inhibited.

To continue press this button again.





MIX

Displays the teletext pages superimposed on the TV picture. To switch the TV picture off press this button again.



TIME

When viewing a TV programme, press this button to display the time at the top right hand corner of the screen. Press this button again to remove the display. In the teletext mode, press this button to select a sub page number. The sub page number is displayed at the bottom of the screen. To hold or change the sub page, press the RED/GREEN,  /  or NUMBER buttons.

Press again to exit this function.

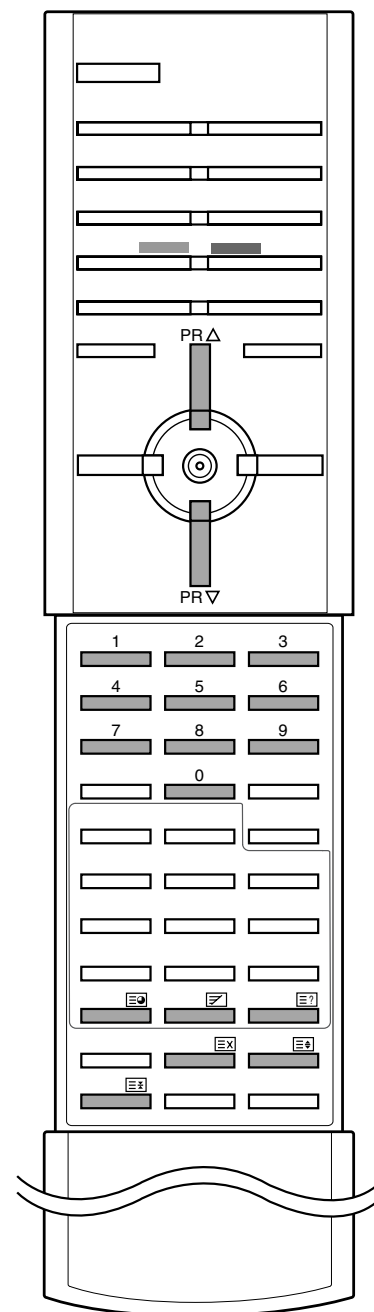

Connection of external equipment

You can connect additional equipment, such as VCRs, camcorders etc. to your set. Examples are shown below.

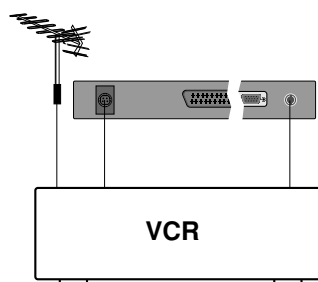

Aerial socket

1. Connect the RF out socket of the VCR to the aerial socket of the set.
2. Connect the aerial cable to the RF aerial in socket of the VCR.
3. Store the VCR channel on a desired programme number using the 'Manual programme tuning' section.
4. Select the programme number where the VCR channel is stored.
5. Press the **PLAY** button on the VCR.

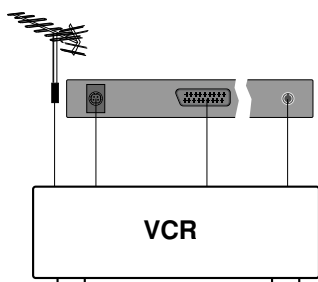

Euro scart socket

1. Connect the Euro scart socket of the VCR to the Euro scart socket of the set.
2. Press the **PLAY** button on the VCR.
If your VCR outputs an AV switching signal via the Scart lead the set will auto switch to **AV 1** mode on start of playback, but if you want to keep on watching in TV mode, press the **▲ / ▼** or **NUMBER** buttons.

Otherwise press the **TV/AV** button on the remote control handset to select **AV1**. The VCR playback picture appears on the screen.

You can also record programmes received by the TV on video tape.

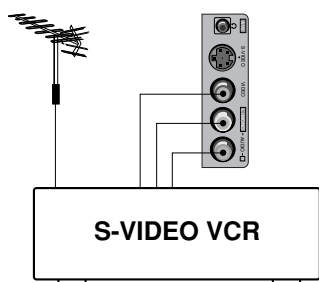

Audio/Video in sockets

1. Connect the audio/video out sockets of the VCR to audio/video in sockets of the set.
2. Press the **TV/AV** button to select **AV2**.
3. Press the **PLAY** button on the VCR.
The VCR playback picture appears on the screen.

Note : If you have a mono VCR, connect the audio cable from the VCR to the **AUDIO L/MONO** socket of the set.

Connection of external equipment

S-Video/Audio in sockets (S-Video) (option)

When connecting an S-VIDEO VCR to the **S-VIDEO** socket, the picture quality will be further improved.

1. Connect the S-Video socket of the VCR to the **S-VIDEO** socket of the set.
2. Connect the audio cable from the S-VIDEO VCR to the **AUDIO** sockets of the set.
3. Select **S-Video** by pressing the **TV/AV** button repeatedly.
4. Press the **PLAY** button on the VCR.
The VCR playback picture appears on the screen.

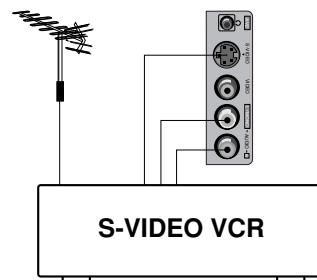

Headphone socket

Insert the headphone plug to the headphone socket of the set. You can listen to the sound through the headphone. To adjust the headphone volume, press the ◀ / ▶ button. If you press the **MUTE** button, the sound from the headphone is switched off.

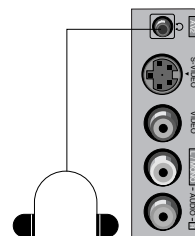

Connection of PC

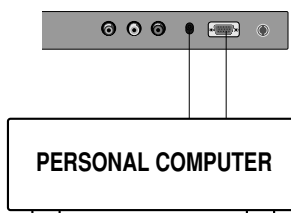

PC in socket (D-Sub jack)

1. Connect the signal cable from the monitor output socket of the PERSONAL COMPUTER to the PC input socket of the set.
2. Connect the audio cable from the PC to the **PC SOUND** sockets of the set.
3. Press the **TV/AV** or **MULTIMEDIA** button to select **PC**.
4. Switch on the PC, and the PC screen appears on the set.
The set can be operated as the PC monitor.

Note : If you have an Apple macintosh, connect the VGA desktop block (not supplied) from the 3 row 15 pin to 2 row 15 pin with the signal cable and connect the VGA desktop block to the Macintosh.

Displayable Monitor Specification

MODE	Resolution	Horizontal Frequency(KHz)	Vertical Frequency(Hz)
VGA	640x480	31.4KHz	60Hz
	640x480	35KHz	67Hz
	640x480	37.5KHz	75Hz
	640x480	43.2KHz	85Hz
SVGA	800x600	35.1KHz	56Hz
	800x600	37.8KHz	60Hz
	800x600	48KHz	72Hz
	800x600	46.8KHz	75Hz
(MAC)	800x600	53.6KHz	85Hz
	832x624	49.7KHz	75Hz
XGA	1024x768	48.3KHz	60Hz
	1024x768	56.4KHz	70Hz
	1024x768	60KHz	75Hz
	1024x768	68.6KHz	85Hz
WXGA	1280x768	39.5KHz	50Hz
	1280x768	47.6KHz	60Hz

(Synchronization input form : separate)

Note :

- a. If the set is cold, there may be a small "flicker" when the set is switched on. This is normal, there is nothing wrong with the set.
- b. If possible, use the VESA 1,024x768@60Hz video mode to obtain the best image quality for your LCD monitor. If used under the other resolutions, some scaled or processed pictures may appear on the screen. If used to PC vertical frequency 85Hz, some noise can be seen when PIP is on. In this case, set the PC vertical frequency to 60Hz. The set has been pre-adjusted to the mode VESA 1,024x768@60Hz.
- c. Some dot defects may appear on the screen, like Red, Green or Blue spots. However, this will have no impact or effect on the monitor performance.
- d. Do not press the LCD screen with your finger for a long time as this may produce some temporary distortion effects on the screen.
- e. When the PC screen appears on the set, a message may appear on the screen, and the message will differ according to the Window system version (Win98, 2000). If a message appears click "Next" until the message finishes.
- f. If the message "out of Range" appears on the screen, adjust the PC as in the 'Displayable Monitor Specification' section.

DPM (Display Power Management) mode

When the PC is in the power saving mode, automatically the monitor goes into DPM mode to save the energy.

Note : Use the supplied signal cable with the set. Otherwise, **DPM** mode may not work.

Connection of PC

Menu selection

1. Press the **MENU** button and then ▲ / ▼ button to display each menu.
2. Press the ► button and then ▲ / ▼ button to select a menu item.
3. Change the setting of an item in the sub menu or the pull-down menu with ◀ / ▶.
You can move to the higher level menu by pressing the **OK** button and to move to the lower level menu by pressing the **MENU** button.

Note :

- a. See 'Picture adjustment' section to adjust the picture.
- b. See 'Sound adjustment' section to adjust the sound.
- c. See 'TV, AV, DVD and PC modes' section to select TV, AV1, AV2, S-Video, DVD or RGB-PC.

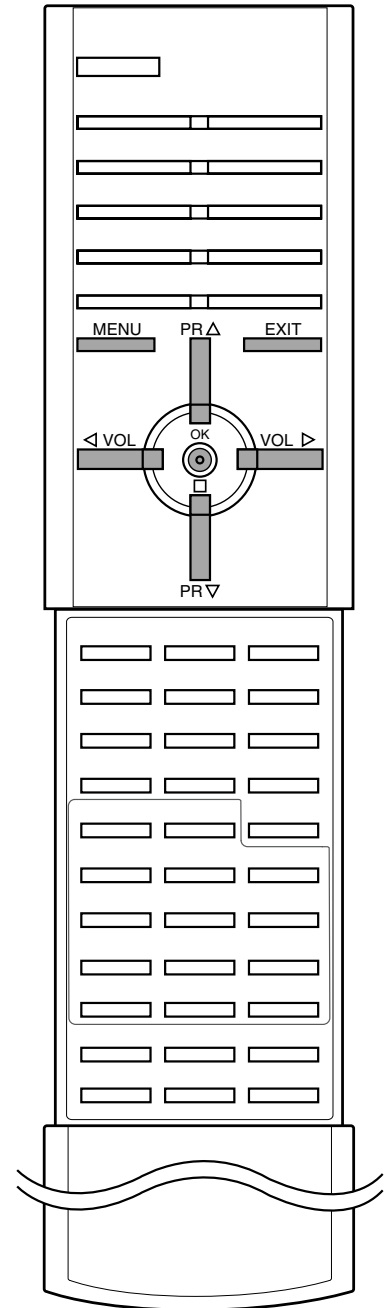
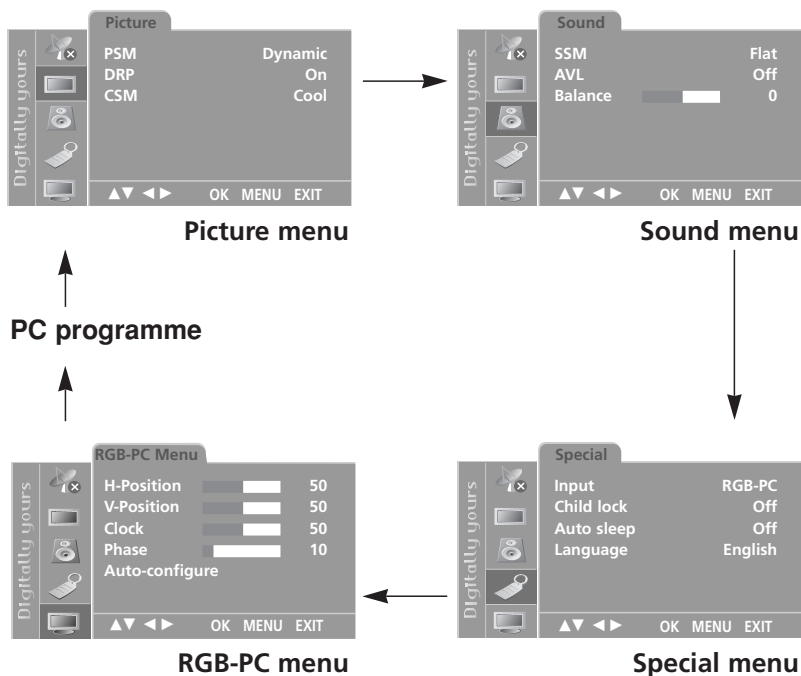

Connection of PC

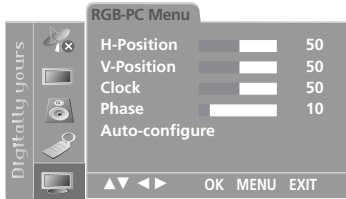

PC Setup

You can adjust horizontal/vertical position, clock, phase, and auto-configure as you prefer.

1. Press the **MENU** button and then **▲ / ▼** button to select the RGB-PC menu.
2. Press the **OK** or **▶** button and then **▲ / ▼** button to select the desired picture item.

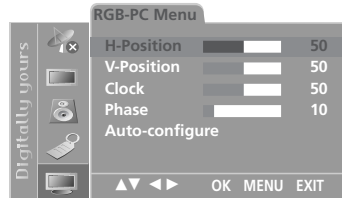

3. Press the **◀ / ▶** button to make appropriate adjustments.

H-Position / V-Position

This function is to adjust picture to left/right and up/down as you prefer.

Clock

This function is to minimize any vertical bars or stripes visible on the screen background. And the horizontal screen size will also change.

Phase

This function allows you to remove any horizontal noise and clear or sharpen the image of characters.

Auto-configure

This function is for the automatic adjustment of the screen position, clock and phase. The displayed image will disappear for a few seconds while the Auto-configuration is in progress.

Note : Some signal from some graphics boards may not function properly. If the results are unsatisfactory, adjust your monitor's position, clock and phase manually.

4. Press the **OK** button to store it for the PC monitor picture.
5. Press the **EXIT** button to return to PC mode.

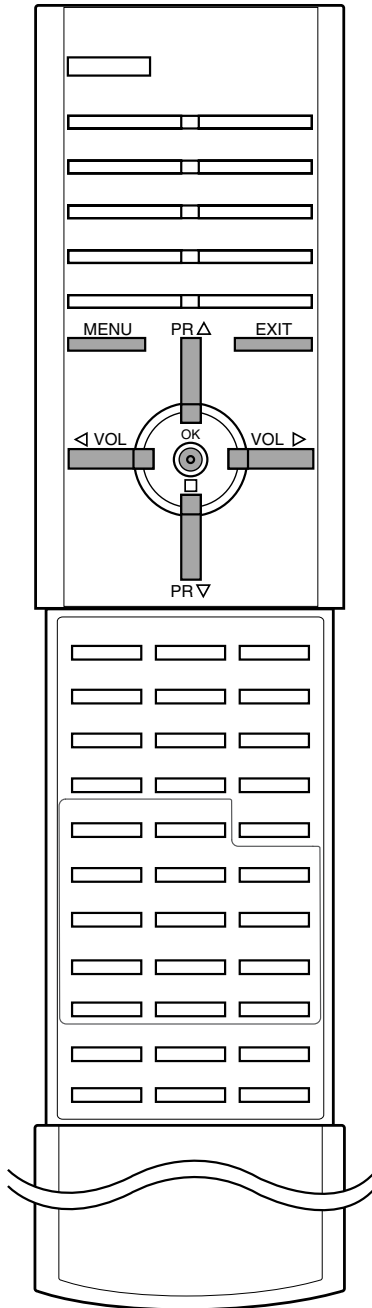

DVD Operation

Notes on discs

On handling discs

- Do not touch the playback side of the disc.
- Do not attach paper or tape to discs.

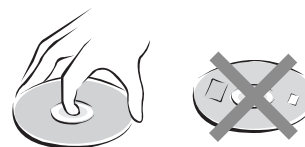

On storing discs

- Do not store discs in a place subject to direct sunlight or near heat sources.
- Do not store discs in place subject to moisture and dust such as a bathroom or near a humidifier.
- Store discs vertically in a case. Stacking or placing object on discs outside of their case may cause warping.

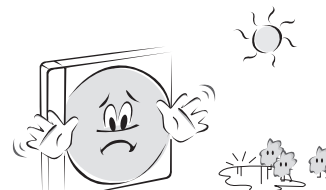

On cleaning discs

- Fingerprints and dust on the disc cause picture and sound deterioration. Wipe the disc from the center outward with a soft cloth. Always keep the disc clean.
- Do not use any type of solvent such as thinner, benzene, commercially available cleaners or antistatic spray for vinyl LPs. It may damage the disc.



Note : “⊙” may appear on the TV screen during operation. A “⊘” means that the operation is not permitted by the unit or the disc.

Structure of disc contents

DVD video disc

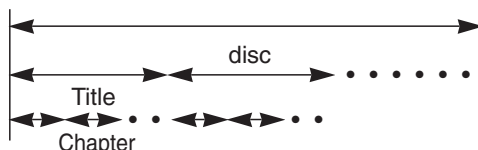

Video CD/Audio CD

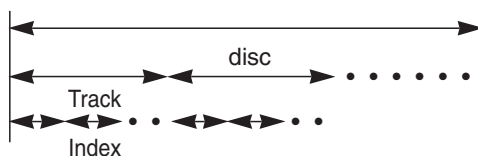

- **Title :** When two or more movies are recorded on a disc, the disc is divided into two or more sections. Each section is called a “TITLE”.
- **Chapter :** The titles can be subdivided into many sections. Each section is called a “CHAPTER”.
- **Track :** An audio CD can contain several items. These are assigned to the tracks.

Note : If an MP3 or JPEG file CD is created using an incorrect method, the player may not be able to recognize it. If this happens, try reburning another CD after setting up the disc writing parameters correctly on your PC.

CAUTION:

This Digital Video Disc Player employs a Laser System.

CLASS 1 LASER PRODUCT
KLASSE 1 LASER PRODUKT
LUOKAN 1 LASER LAITE
KLASS 1 LASER APPARAT
CLASSE 1 PRODUIT LASER

To ensure proper use of this product, please read this owner's manual carefully and retain for future reference should the unit require maintenance, contact an authorized service location (see service procedure). Use of controls, adjustments, or the performance of procedures other than those specified herein may result in hazardous radiation exposure. To prevent direct exposure to laser beam, do not try to open the enclosure. Visible laser radiation when open. **DO NOT STARE INTO BEAM.**

CAUTION: The apparatus should not be exposed to water (dripping or splashing) and no objects filled with liquids, such as vases, should be placed on the apparatus.

Regional code of the DVD player and DVDs

This DVD player is designed and manufactured for playback of region “2” encoded DVD software. The region code on the labels of some DVD discs indicates which type of player can play those discs. This unit can play only DVD discs labeled “2”. If you try to play any other discs, the message “Check Regional Code” will appear on the TV screen. Some DVD discs may not have a region code label even though their playback is prohibited by area limits.



“DTS” and “DTS Digital Surround” are trademarks of Digital Theater System, Inc.

APPARATUS CLAIMS OF U.S. PATENT NOS. 4,631,603, 4,577,216, 4,819,098, AND 4,907,093 LICENSED FOR LIMITED VIEWING USER ONLY.

DVD Operation

Playing a disc

Basic playback

1. Press the **POWER** button to switch the set on.
2. Insert the disc into the side DVD slot after facing a logo-printed side to front. Playback starts.

To pause playback (still mode)

1. Press the **PLAY/PAUSE ►/II** button during playback.
2. Press the **PLAY/PAUSE ►/II** button again to return to normal playback.

To stop playback

Press the **STOP** button to stop playback.

Note :

- a. To stop playback fully, press the **STOP** button in twice.
- b. In TV, AV or RGB-PC mode, to return to DVD mode, press the **PLAY/PAUSE ►/II** button.
- c. In DVD mode, to return to TV mode, press the **SWAP** button.
- d. When you use a NTSC disc, the picture may be unstable. In that case, press the **REPEAT** button on the side panel to select NTSC broadcasting system for a moment after extracting the disc.

To remove the disc

Press the **OPEN/CLOSE** button and remove the disc after the disc completely ejected.

Playing in fast reverse or fast forward directions (for DVD, Video CD and Audio CD)

1. Press the **SCAN ►►** or **◄◄ SCAN** button during playback.
2. Each time you press **SCAN ►►** or **◄◄ SCAN** button, the playback speed changes.
3. Press the **PLAY/PAUSE ►/II** button to resume normal playback.

Playing in slow reverse or slow forward directions (for DVD and Video CD)

1. Press the **PLAY/PAUSE ►/II** button and then press **SCAN ►►** or **◄◄ SCAN** button.
2. Each time you press **SCAN ►►** or **◄◄ SCAN** button, the playback speed changes.

Note : There is no sound when viewing **FAST** or **SLOW** playback in DVD and Video CD.

Locating a chapter or track

Press the **SKIP ►►I** button Forward or **I◄◄ SKIP** button Reverse during playback to locate a chapter that you want to watch. Each time you press the button, a chapter or track is skipped.

Note :

- a. If you press the **SKIP ►►I** button Forward or **I◄◄ SKIP** button Reverse in the still mode, one frame is displayed at a time.
- b. Depending on the disc, this function maybe operate differently.

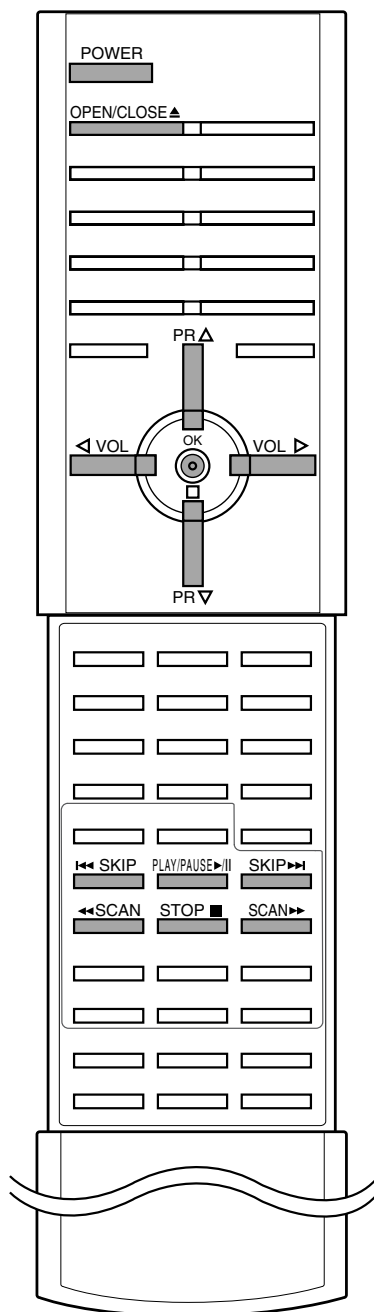

DVD Operation

OSD (On-screen Display)

You can display the playback status on TV screen as following; Title, Chapter number, Playing time. Press the **OK** button during playback. Title, Chapter information appears on screen. Each time you press the **OK** button, the OSD changes as follows.

DVD : **Title Elapsed** -> **Title Remain** -> **Chapter Elapsed** ->
Chapter Remain -> **Display off**
VCD : **Single Elapsed** -> **Single Remain** -> **Total Elapsed**
-> **Total Remain** -> **Display off**
Audio CD : **Single Elapsed** -> **Single Remain** ->
Total Elapsed -> **Total Remain**

Playing MP3 discs

Load a MP3 disc

1. MP3 menu screen is displayed automatically depending on MP3 disc's folder (directory) structure as shown below.
2. Using the **▲ / ▼** or **◀ / ▶** button to find the desired folder.

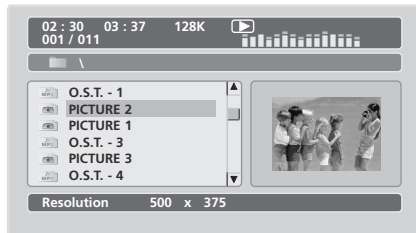

3. Press the **OK** button to select.
4. Using the **▲ / ▼** button to find the desired MP3 title. Press the **OK** button to select.

Playing JPEG file

When a JPEG file is loaded, the table of contents is displayed on TV screen. 16 slide show transition modes are provided. Use **PROGRAM** button to switch the slide show transition mode.

Transition modes

Wipe Top -> **Wipe Bottom** -> **Wipe Left** -> **Wipe Right**
-> **Diagonal Wipe Left Top** -> **Diagonal Wipe Right Top** ->
Diagonal Wipe Left Bottom -> **Diagonal Wipe Right Bottom**
-> **Extend From Center H** -> **Extend From Center V** ->
Compress To Center H -> **Compress To Center V**
-> **Window H** -> **Window V** -> **Wipe From Edge To Center** ->
Move in From Top -> **None**

Select the picture

Selecting the picture, you want to see, by pressing the **▲ / ▼** button. The selected item shows as small size picture on the right side of File Menu Screen. Press the **OK** or **PLAY/PAUSE ▶/II** button to display the picture on the full screen. Press the **PLAY/PAUSE ▶/II** button to start slide show.

Note : If you press the **OK** or **PLAY/PAUSE ▶/II** button while playing MP3 disc, the picture starts slide show.

Image rotation and zoom

There are 2 modes to rotate a picture :
▲ button : invert / **▼** button : mirror

Press the **ZOOM** button and viewing zoom mode in 50% ~ 200%, by pressing the **SCAN ▶▶** or **◀◀ SCAN** button. Adjust the picture position with the **▲ / ▼** or **◀ / ▶** buttons in enlarged picture mode. To finish ZOOM mode, press the **ZOOM** button one more time.

To finish viewing picture, press the **STOP** button.

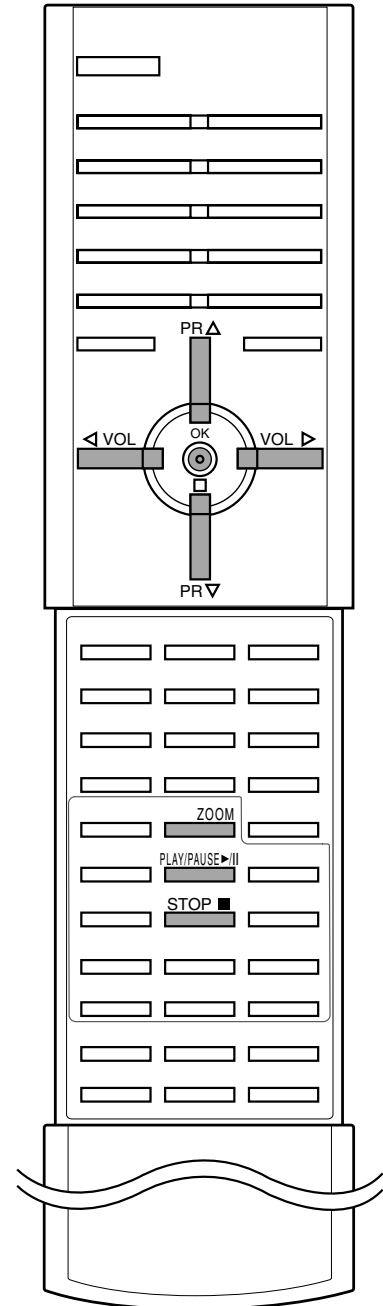

DVD Operation

Selecting disc menu

1. Press the **DISC MENU** button during playback.
2. Press the **▲ / ▼**, **◀ / ▶**, **OK** or **NUMBER** buttons to select the desired item.

Selecting title menu

1. Press the **TITLE MENU** button during playback.
2. Press the **▲ / ▼**, **◀ / ▶**, **OK** or **NUMBER** buttons to select the desired item.

Note : In some disks, you can't select the disc or title menu.

Repeat playback

You can play a specific title, chapter, track or segment repeatedly.

Press the **REPEAT** button during playback.
Each time you press the **REPEAT** button, the repeat mode changes as follows.

DVD : **Chapter -> Title -> ALL -> Repeat Off**
VCD : **Track -> ALL -> Repeat Off**
Audio CD : **Track -> ALL -> Random -> Repeat Off**
MP3 : **Random -> Track -> Repeat Track -> Repeat Directory -> Off**

Note : Depending on the disc, repeat playback may not be possible.

A-B repeat playback

A-B repeat playback allows you to repeat material between two selected points.

1. Press the **A-B** button to select the start point during playback.
2. Press the **A-B** button again to select the end point.
Playback starts at the point that you selected. Playback stops at the end point, returns to Point A automatically, then starts again.
3. Repeatedly press the **A-B** button again to resume normal playback.
“Off” appears on the screen.

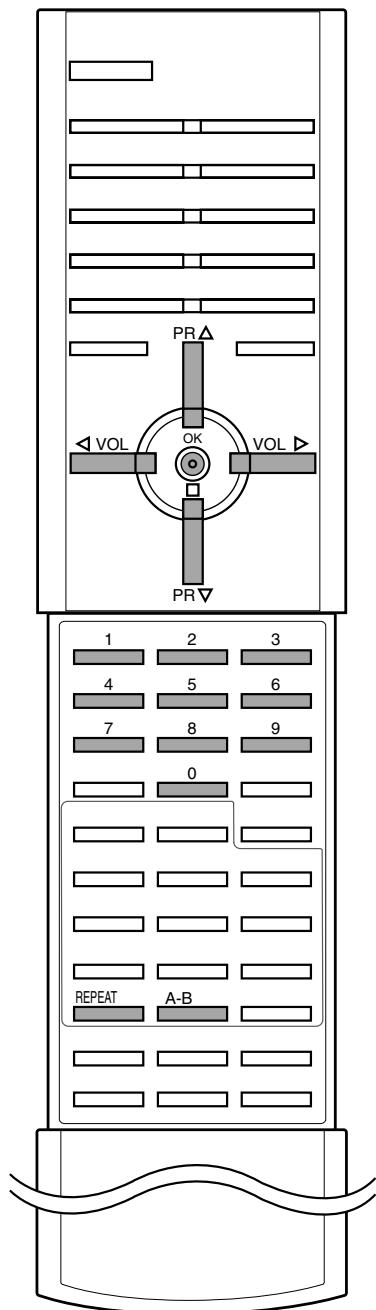

DVD Operation

Programme playback

You can arrange the order of tracks on the disc.

1. Press the **PROGRAM** button in the stop mode or during playback.
2. Press the **▲ / ▼** button to select the programme position.
3. Press the **NUMBER** buttons to input the desired Title or Track numbers.

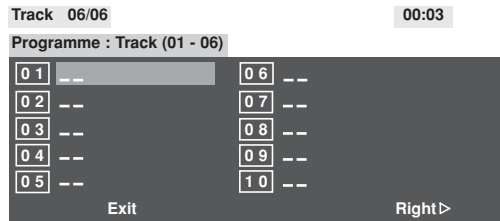

To programme others, repeat Step 2 to 3.

4. Press the **PROGRAM** button to resume normal playback.

Note : Depending on the disc, programme playback may not be possible.

Selecting the camera angle

If your scene was recorded from multiple angles, you can easily change the camera angle of the scene you are watching.

1. Press the **ANGLE** button during playback.
2. Repeatedly press the **ANGLE** button to select the desired angle.

Note :

- a. You can only change the angle for DVDs that provide multiple angles of scenes.
- b. The angle function will not work on DVD video discs that do not contain recorded multiple angles.
- c. The number of angles varies from disc to disc.

3D sound

To enjoy various surround sounds, when you can select any desired sound effect by pressing the **3D SOUND** button.

1. Press the **3D SOUND** button during playback.
2. Each press of the **3D SOUND** button changes the sound display as shown below.

Reverb

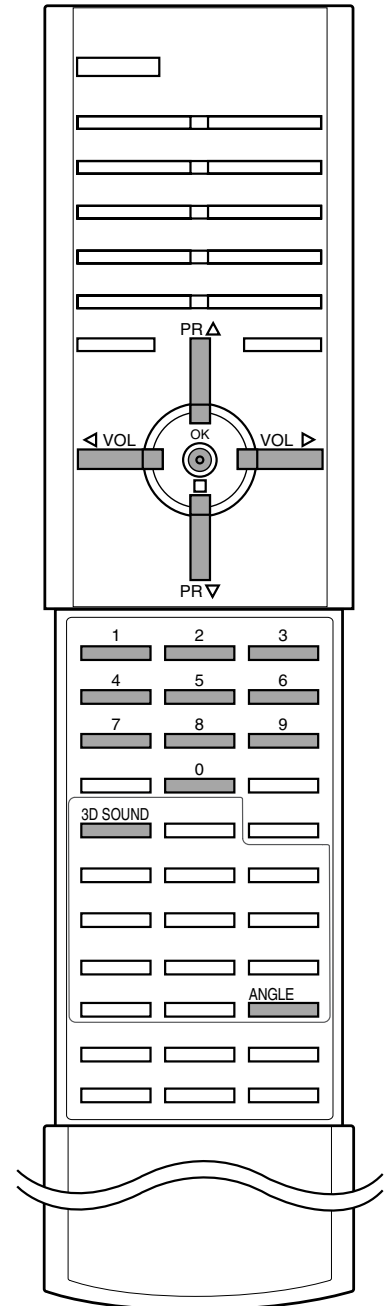
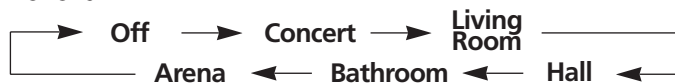

DVD Operation

Picture size zoom (for DVD and Video CD)

When enlarging or reducing the picture, the screen may be display unnatural picture.

1. Press the **ZOOM** button in the stop mode or during playback.
2. Each press of the **ZOOM** button changes the screen display as shown below.
2x -> 3x -> 4x -> 1/2 -> 1/3 -> 1/4
3. Adjust the main picture position with the ▲ / ▼ / ◀ / ▶ buttons in enlarged picture mode.

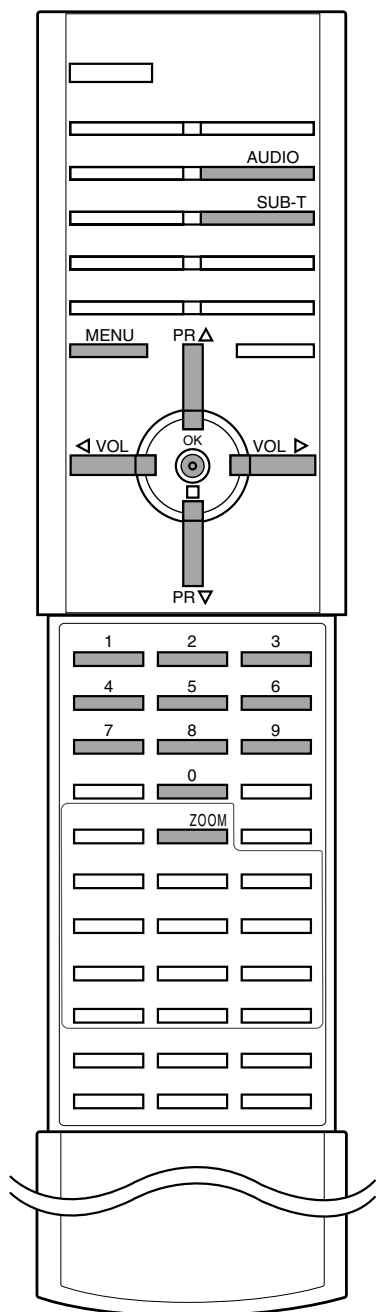

Selecting a audio language (STOP mode only)

Set this value to the preferred audio language. If an audio language is selected, whenever you start playing a new disc, the selected audio language is played. (If the selected language is contained in the disc.)

1. Press the **MENU** button in twice and then use the ▲ / ▼ button to select **Audio Language**.
2. Press the ▶ button and then ▲ / ▼ button to select your desired language.

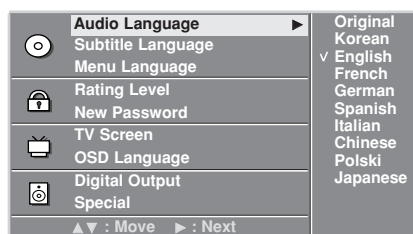

3. Press the **OK** button.
4. Press the **MENU** button to resume normal playback.

You can also select a desired audio language with **AUDIO** button on the remote control.

Selecting a subtitle language (STOP mode only)

Set this value to the preferred subtitle language. If a subtitle language is selected, whenever you start playing a new disc, the selected subtitle language is played. (If the selected language is contained in the disc.)

1. Press the **MENU** button in twice and then use the ▲ / ▼ button to select **Subtitle Language**.
2. Press the ▶ button and then ▲ / ▼ button to select your desired language.

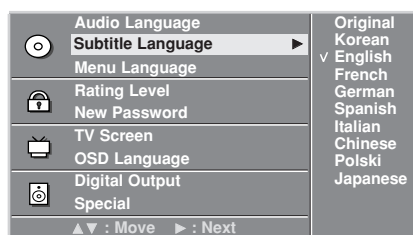

3. Press the **OK** button.
4. Press the **MENU** button to resume normal playback.

You can also select a desired subtitle language with **SUB-T** button on the remote control.

DVD Operation

Disc menu language selection

You can select the language of the disc menu messages of DVDs. (If the selected language is contained in the disc.)

1. Press the **MENU** button in twice and then use the **▲ / ▼** button to select **Menu Language**.
2. Press the **▶** button and then **▲ / ▼** button to select your desired language.

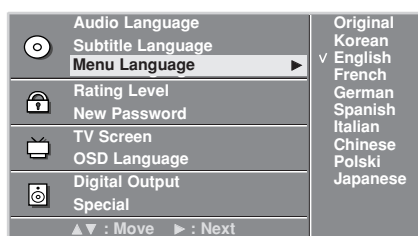

3. Press the **OK** button.
The menu on screen displays will appear in the selected language.
4. Press the **MENU** button to resume normal playback.

Parental control setting

Some discs are specified not suitable for children. Such discs can be prevented from play back with the set.

1. Press the **MENU** button in twice and then use the **▲ / ▼** button to select **Rating Level**.
2. Press the **▶** button and then use **NUMBER** buttons to input a 4-digit password.

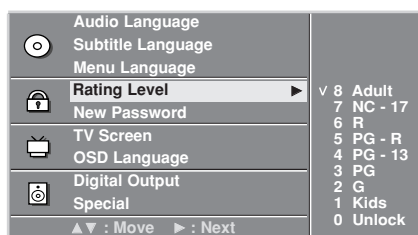

Be sure to remember this number!

If you input a wrong number, press the **EXIT** button.

3. Press the **▲ / ▼** button to select from the level 0 to level 8. The limitation will be more severe as the level number is upper.

Level 0 : The parental control setting does not function.

Level 1 : DVD software for adults cannot be played back.

Level 8 : All DVD software can be played back.

4. Press the **MENU** button to resume normal playback.

Note : If you forgot your password, press '7', '7', '7', '7' on the remote control handset.

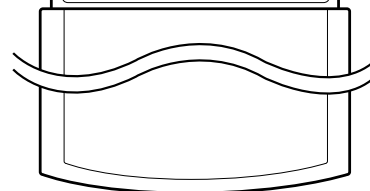
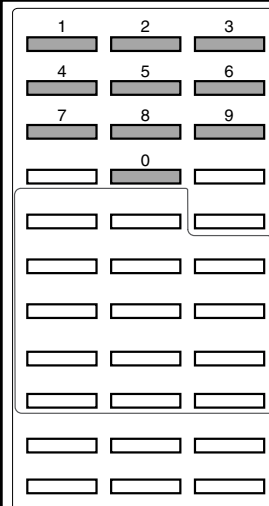
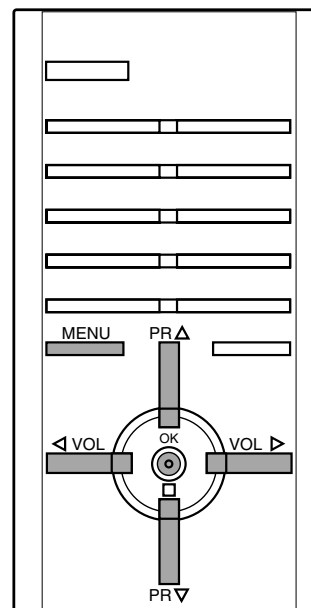

DVD Operation

To change the password

1. Press the **MENU** button in twice and then use the ▲ / ▼ button to select **Rating Level**.
2. Press the ► button and then use NUMBER buttons to input a 4-digit password.
3. Press the ◀ button and then use the ▲ / ▼ button to select **New Password**.

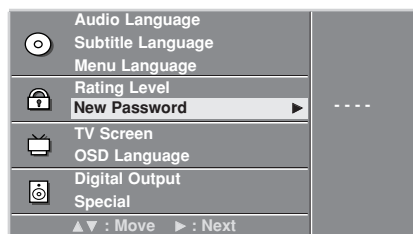

4. Press the ► button and then enter your new password in 4 digits.
5. Re-enter new password for confirm. Password change is finished.
6. Press the **MENU** button to resume normal playback.

TV Screen

You can watch TV in various picture formats.

1. Press the **MENU** button in twice and then use the ▲ / ▼ button to select **TV Screen**.

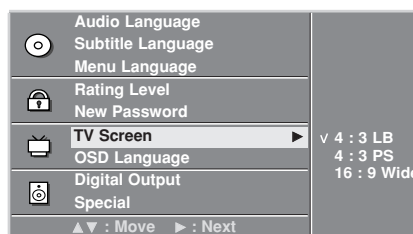

2. Press the ► button and then ▲ / ▼ button to select **4 : 3 LB**, **4 : 3 PS**, or **16 : 9 Wide**.



Letter Box (4:3 LB) Pan & Scan (4:3 PS) 16:9 Wide

3. Press the **OK** button.
4. Press the **MENU** button to resume normal playback.

Note : Depending on the disc, TV screen function may not be possible.

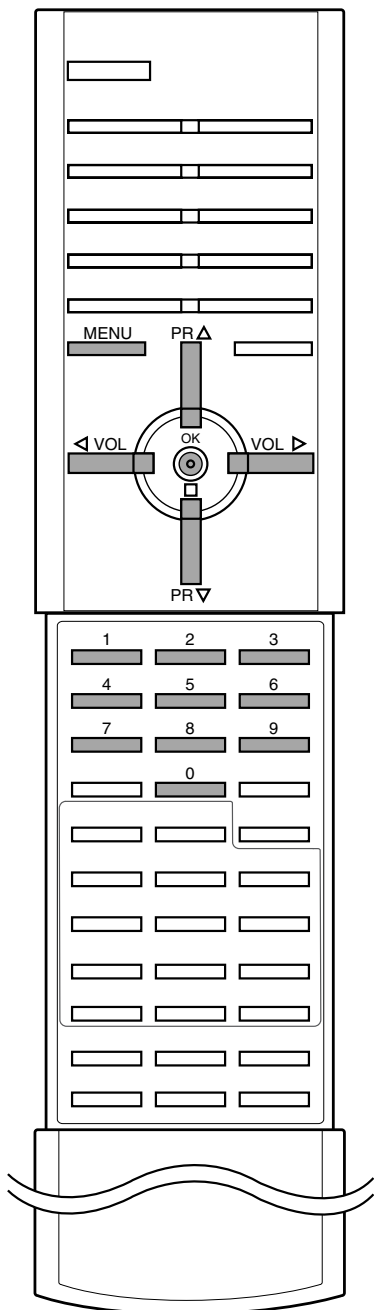

DVD Operation

Disc OSD language selection (option)

The menu can be displayed on the screen in your desired language. First select your language. (If the selected language is contained in the disc.)

1. Press the **MENU** button in twice and then use the ▲ / ▼ button to select **OSD Language**.
2. Press the ► button and then ▲ / ▼ button to select your desired language.
All the on screen displays will appear in the selected language.
3. Press the **MENU** button to resume normal playback.

Note : On some models, the **OSD Language** will not be displayed.

Selecting digital audio output

1. Press the **MENU** button in twice and then use the ▲ / ▼ button to select **Digital Output**.
2. Press the ► button and then ▲ / ▼ button to select **Bitstream** or **PCM**.

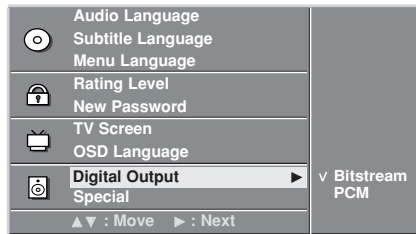

3. Press the **OK** button.
4. Press the **MENU** button to resume normal playback.

DRC (Dynamic Range Compression)

DRC (Dynamic Range compression) enables you to control the dynamic range so as to achieve a suitable sound for your equipment.

1. Press the **MENU** button in twice and then use the ▲ / ▼ button to select **Special**.
2. Press the ► button and then ▲ / ▼ button to select **DRC Off** or **DRC Full**.

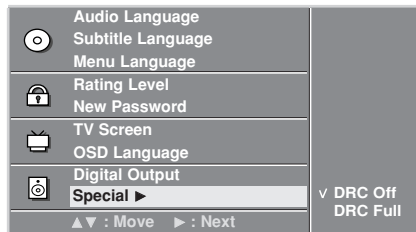

4. Press the **OK** button.
5. Press the **MENU** button to resume normal playback.

